



DENTAL INSTRUMENTS

// MAIN CATALOG





Located in the world's capital of medical technology, we are committed to supplying distributors all around the world.

Our Instruments are made out of the highest quality stainless steel, manufactured with state-of-the-art machinery by highly trained professionals to meet all international standards.

We offer solutions for all types of surgeries. Our product range consists of more than 15.000 different surgical, dental, veterinary instruments and sterilization container systems.



Large Stocks

We maintain a large stock of all products that are offered by us. This enables us to process orders in a matter of days.



Full Range











As a manufacturer based in Tuttlingen, we are able to supply you with every existing surgical instrument in a short amount of time. We accept orders with article codes of competitors as well.



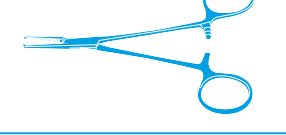

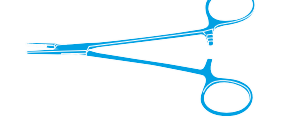
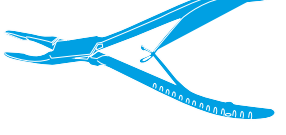





Premium Quality

Our instruments are manufactured at our own factory in Tuttlingen, the world's center of medical technology. We supply premium quality exclusively.

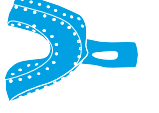
// 100% Made in Pakistan // 5 Years Warranty // Fast Delivery

01	SAUGROHRE SUCTION TUBES TUBES D'ASPIRATION TUBOS DE ASPIRACIÓN TUBI DI ASPIRAZIONE		1 - 4
02	SKALPELLE & MESSER SCALPEL & KNIVES BISTOURIS & COUTEAUX BISTURÍ Y CUCHILLOS BISTURI & COLTELLI		5 - 10
03	SCHEREN SCISSORS CISEAUX TJERAS FORBICI		11 - 26
04	PINZETTEN FORCEPS PINCES PINZAS PINZE		27 - 38
05	ARTERIENKLEMMEN HEMOSTATIC FORCEPS PINCES HÉMOSTATIQUES PINZAS HEMOSTÁTICAS PINZE EMOSTATICHE		39 - 44
06	WUNDHAKEN RETRACTORS ECARTEURS SEPARADORES DIVARICATORI		45 - 52
07	NADELHALTER NEEDLE HOLDERS PORTE-AIGUILLES PORTA-AGUJAS PORT'AGHI		53 - 60
08	ORTHOPÄDIE ORTHOPAEDICS ORTHOPÉDIE ORTOPEDIA ORTOPEDIA		61 - 80
09	KNOPFSONDEN PROBES SONDES BOUTONNÉES SONDAS ABOTONADAS SONDE A BOTTONE		81 - 82
10	MUND UND ZUNGE MOUTH AND TONGUE BOUCHE ET LANGUE BOCA Y LENGUA BOCCA E LINGUA		83 - 90
11	ZAHNZANGEN EXTRACTING FORCEPS DAVIERS PINZAS PINZE		91 - 126
12	KINDERZAHNZANGEN EXTRACTING FORCEPS FOR CHILDREN DAVIERS POUR ENFANTS PINZAS DE EXTRACCIÓN PARA NIÑOS PINZE PER ESTRAZIONE PER BAMBINI		127 - 138

13	WURZELHEBER ROOT ELEVATORS ELÉVATEURS DE RACINES ELEVADORES PARA RAÍCES LEVE PER RADICI		139 - 154
14	AMPULLENSPRITZEN CARTRIDGE SYRINGES SERINGUES POUR AMPOULE JERINGAS DE CARTUCHO SIRINGE DI CARPULE		155 - 160
15	MUNDSPIEGEL MOUTH MIRRORS MIROIRS DENTAIRES ESPEJOS DE BOCA SPECCHIETTI DI BOCCA		161 - 166
16	PARODONTOLOGIE PERIODONTOLOGY PARODONTOLOGIE PARODONTOLOGÍA PARODONTOLOGIA		167 - 190
17	FÜLLUNGSTRUMENTE FILLING INSTRUMENTS INSTRUMENTS POUR PLOMBAGES INSTRUMENTOS PARA OBTURACIONES OTTURATORI		191 - 208
18	PROTHETIK PROSTHETICS PROTHÈSES PRÓTESIS PROTESI		209 - 222
19	TECHNIKZANGEN MEDICAL PLIERS PINCES PROTHÉTIQUES PINZA PARA TÉCNICA TENAGLIE PER TECNICA		223 - 236
20	HYGIENE HYGIENE HIGIENNE HYGIÈNE IGIENE		237 - 242
21	VERSCHIEDENES MISCELLANEOUS DIVERS DIVERSOS DIVERSI		243 - 246
22	HOCHFREQUENZ-CHIRURGIE HIGH FREQUENCY SURGERY CHIRURGIE À HAUTE FRÉQUENCE ELECTROCIRUGÍA ELETTROCHIRURGIA		247 - 250
23	NUMMERISCHES VERZEICHNIS NUMERICAL INDEX INDEX NUMÉRIQUE ÍNDICE NUMÉRICO INDICE NUMERICO		251 - 256
24	INHALTSVERZEICHNIS ALPHABETIC INDEX INDEX ALPHABÉTIQUE ÍNDICE ALFABÉTICO INDICE ALFABETICO		257 - 260

01

- SAUGROHRE
SUCTION TUBES
TUBES D'ASPIRATION
TUBOS DE ASPIRACIÓN
TUBI DI ASPIRAZIONE





½

COUPLANT AUFSATZ

04.165.01	9 cm 3½"	ø 1,5 mm
04.165.02	9 cm 3½"	ø 2,0 mm
04.165.03	9 cm 3½"	ø 2,5 mm
04.165.04	9 cm 3½"	ø 3,5 mm
04.165.11	9 cm 3½"	ø 1,5 mm
04.165.12	9 cm 3½"	ø 2,0 mm
04.165.13	9 cm 3½"	ø 2,5 mm
04.165.14	9 cm 3½"	ø 3,5 mm

Spitze seitlich perforiert
tip laterally perforated
pointe côté perforée
punta perforada lateralmente
punta con perforazione laterale



½

COUPLAND

04.165.00	16,5 cm 6½"
-----------	---------------



½

BYRD

04.170.01	21,5 cm 8½"	ø 1,5 mm
04.170.02	21,5 cm 8½"	ø 2,5 mm
04.170.03	21,5 cm 8½"	ø 3,5 mm



½

04.171.15	14 cm 5½"	ø 1,5 mm
04.171.02	14 cm 5½"	ø 2,0 mm
04.171.25	14 cm 5½"	ø 2,5 mm
04.171.03	14 cm 5½"	ø 3,0 mm
04.171.04	14 cm 5½"	ø 4,0 mm
04.171.05	14 cm 5½"	ø 5,0 mm
04.171.06	14 cm 5½"	ø 6,0 mm

04.172.15	17 cm 6¾"	ø 1,5 mm
04.172.02	17 cm 6¾"	ø 2,0 mm
04.172.25	17 cm 6¾"	ø 2,5 mm
04.172.03	17 cm 6¾"	ø 3,0 mm
04.172.04	17 cm 6¾"	ø 4,0 mm
04.172.05	17 cm 6¾"	ø 5,0 mm
04.172.06	17 cm 6¾"	ø 6,0 mm

Saugkanülen mit Unterbrecher und Mandrin
suction cannula with finger cut-off and stylet
canules d'aspiration avec interrupteur à doigt et stylet
cánulas para aspiración con interruptor y estilete
cannule per aspirazione con interruttore e stiletto



½

FRAZIER 19 cm | 7½"

40.295.06	30° 12,5 cm 5"	ø 2,0 mm
40.295.07	30° 12,5 cm 5"	ø 2,3 mm
40.295.08	30° 12,5 cm 5"	ø 2,7 mm
40.295.09	30° 12,5 cm 5"	ø 3,0 mm
40.295.10	30° 12,5 cm 5"	ø 3,3 mm
40.295.11	30° 12,5 cm 5"	ø 3,7 mm
40.295.12	30° 12,5 cm 5"	ø 4,0 mm
40.295.15	30° 12,5 cm 5"	ø 5,0 mm

40.297.06	75° 12,5 cm 5"	ø 2,0 mm
40.297.07	75° 12,5 cm 5"	ø 2,3 mm
40.297.08	75° 12,5 cm 5"	ø 2,7 mm
40.297.09	75° 12,5 cm 5"	ø 3,0 mm
40.297.10	75° 12,5 cm 5"	ø 3,3 mm
40.297.11	75° 12,5 cm 5"	ø 3,7 mm
40.297.12	75° 12,5 cm 5"	ø 4,0 mm
40.297.15	75° 12,5 cm 5"	ø 5,0 mm



½

FERGUSSON 18,5 cm | 7¼"

40.270.15	11 cm 4¼"	ø 1,5 mm
40.270.20	11 cm 4¼"	ø 2,0 mm
40.270.25	11 cm 4¼"	ø 2,5 mm
40.270.30	11 cm 4¼"	ø 3,0 mm
40.270.40	11 cm 4¼"	ø 4,0 mm
40.270.50	11 cm 4¼"	ø 5,0 mm

FERGUSSON 20,5 cm | 8"

40.271.15	13 cm 5"	ø 1,5 mm
40.271.20	13 cm 5"	ø 2,0 mm
40.271.25	13 cm 5"	ø 2,5 mm
40.271.30	13 cm 5"	ø 3,0 mm
40.271.40	13 cm 5"	ø 4,0 mm
40.271.50	13 cm 5"	ø 5,0 mm



SAUGROHRE
SUCTION TUBES
TUBES D'ASPIRATION
TUBOS DE ASPIRACIÓN
TUBI DI ASPIRAZIONE



½

ADSON

40.290.21 21 cm | 8¼" ø 4 mm



½

LUER 16,5 cm | 6½"

40.282.30 11 cm | 4¼" ø 3,0 mm
40.282.35 11 cm | 4¼" ø 3,5 mm
40.282.45 11 cm | 4¼" ø 4,5 mm



½

PLESTER

40.313.15 19,5 cm | 7¾" ø 1,5 mm
40.313.20 19,5 cm | 7¾" ø 2,0 mm
40.313.25 19,5 cm | 7¾" ø 2,5 mm
40.313.30 19,5 cm | 7¾" ø 3,0 mm

für Schlauch mit ø 6 - 9 mm
for tube with ø 6 - 9 mm
pour tuyau de ø 6 - 9 mm
para tubo con ø 6 - 9 mm
per tubo con ø 6 - 9 mm



½

40.294.05 18 cm | 7" ø 5 mm

für Schlauch mit ø 6 - 9 mm
for tube with ø 6 - 9 mm
pour tuyau de ø 6 - 9 mm
para tubo con ø 6 - 9 mm
per tubo con ø 6 - 9 mm

02

- SKALPELLE & MESSER
SCALPELS & KNIVES
BISTOURIS & COUTEAUX
BISTURIS & CUCHILLOS
BISTURI & COLTELLI

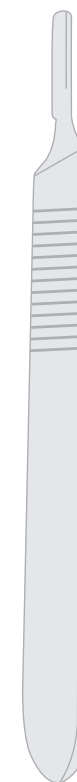



SKALPELLGRIFFE & STERILE SKALPELLKLINGEN
 SCALPEL HANDLES & STERILE SCALPEL BLADES
 MANCHES DE BISTOURI & LAMES DE BISTOURI STÉRILES
 MANGOS DE BISTURÍ & HOJAS DE BISTURÍ ESTÉRILES
 MANICI PER BISTURI & LAME DA BISTURI STERILI

100 Stück
 100 pieces
 100 pièces
 100 piezas
 100 pezzi

passend für
 for
 allant avec
 para
 per
 N° 3, N° 3R, N° 5, N° 7, N° 7K

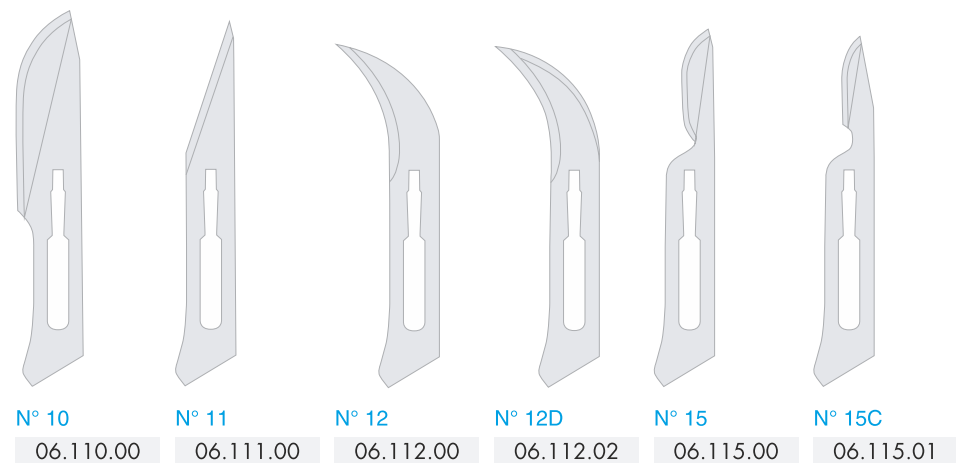

N° 10 06.110.00 **N° 11** 06.111.00 **N° 12** 06.112.00 **N° 12D** 06.112.02 **N° 15** 06.115.00 **N° 15C** 06.115.01

SKALPELLGRIFFE & STERILE SKALPELLKLINGEN
 SCALPEL HANDLES & STERILE SCALPEL BLADES
 MANCHES DE BISTOURI & LAMES DE BISTOURI STÉRILES
 MANGOS DE BISTURÍ & HOJAS DE BISTURÍ ESTÉRILES
 MANICI PER BISTURI & LAME DA BISTURI STERILI



N° 3 06.103.00 12 cm 4¾"
N° 3 06.103.01 12 cm 4¾"
N° 3 06.103.11 12 cm 4¾"

Graduierung in cm
 cm graduation
 graduation en cm
 graduado en cm
 graduato in cm

Zentimeter- und Zollgraduierung
 cm and inch graduation
 graduation en cm et pouces
 graduación en cm y pulgadas
 graduazione in cm e pollici



N° 3R 06.103.03 14,5 cm 5¾"



N° 3R 06.103.33 14 cm 5½"
N° 3R 06.103.15 15 cm 6"



N° 5 06.105.00 16 cm 6¼"
N° 7 06.107.00 16 cm 6¼"
N° 7K 06.107.01 12,5 cm 5"





100 Stück
 100 pieces
 100 pièces
 100 piezas
 100 pezzi

passend für
 for
 allant avec
 para
 per
 N° 4



N° 18
 06.118.00



N° 19
 06.119.00



N° 20
 06.120.00



N° 21
 06.121.00



N° 22
 06.122.00



N° 23
 06.123.00



N° 24
 06.124.00



N° 25
 06.125.00



N° 36
 06.136.00



N° 4
 06.104.00 13,5 cm|5¼"



N° 4
 06.104.01 13,5 cm|5¼"

Graduierung in cm
 cm graduation
 graduation en cm
 graduado en cm
 graduato in cm

10 Stück, steril
 10 pieces, sterile
 10 pièces, stériles
 10 piezas, estériles
 10 pezzi, sterile



N° 10
 06.210.00



N° 11
 06.211.00



N° 12
 06.212.00



N° 12D
 06.212.02



N° 15
 06.215.00



N° 15C
 06.215.01



N° 18
 06.218.00



N° 19
 06.219.00



N° 20
 06.220.00



N° 21
 06.221.00



N° 22
 06.222.00



N° 23
 06.223.00



N° 24
 06.224.00

MIKRO SKALPELLGRIFFE, MIKRO SKALPELLKLINGEN
 MICRO SCALPEL HANDLES, MICRO SCALPEL BLADES
 MICRO MANCHES POUR BISTOURIS, MICRO LAMES DE BISTOURI
 MICRO MANGOS DE BISTURÍ, MICRO HOJAS DE BISTURÍ
 MICRO MANICI PER BISTURI, MICRO LAME PER BISTURI



1/2
 06.199.14 14 cm15 1/2"



1/2
 PARKER
 06.408.01 14 cm15 1/2"



1/2
 PARKER
 06.408.02 14 cm15 1/2"

Skalpellklingenentferner
 scalpel blade remover
 detachelames de bistouris
 removedor para hojas de bisturí
 rimozione per le lame da bisturi



06.199.00 6 cm2 1/2"

03

- SCHEREN
 SCISSORS
 CISEAUX
 TIJERAS
 FORBICI



1/4
 06.304.15 15,5 cm6"



1/4
 06.302.13 13,5 cm5 1/4"



1/4
 06.302.09 9,5 cm3 3/4"

10 Stück, steril
 10 pieces, sterile
 10 pièces, stériles
 10 piezas, estériles
 10 pezzi, sterile



40.859.01



40.859.02



40.859.04



40.859.05



40.859.07



40.859.09

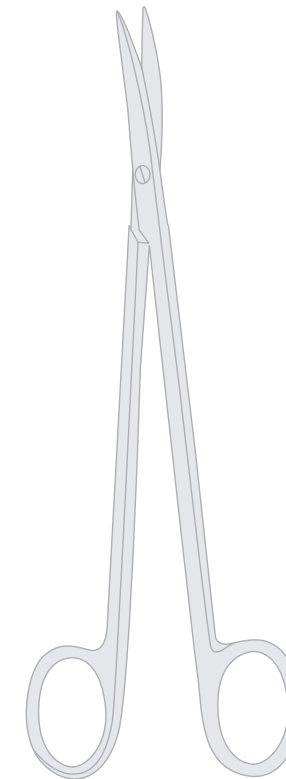



½

½

½

½

- 08.102.13 13 cm 5"
- 08.103.13 13 cm 5"
- 08.102.14 14,5 cm 5¾"
- 08.103.14 14,5 cm 5¾"

- 08.104.14 14,5 cm 5¾"
- 08.105.14 14,5 cm 5¾"

- 08.120.13 13 cm 5"
- 08.121.13 13 cm 5"
- 08.120.14 14,5 cm 5¾"
- 08.121.14 14,5 cm 5¾"

- 08.124.14 14,5 cm 5¾"
- 08.125.14 14,5 cm 5¾"



½

½

½

½

- 08.110.13 13 cm 5"
- 08.111.13 13 cm 5"
- 08.110.14 14,5 cm 5¾"
- 08.111.14 14,5 cm 5¾"

- 08.114.14 14,5 cm 5¾"
- 08.115.14 14,5 cm 5¾"

- 08.122.01 14,5 cm 5¾"
- 08.122.02 14,5 cm 5¾"
- 08.122.03 14,5 cm 5¾"

- 08.123.01 14,5 cm 5¾"
- 08.123.02 14,5 cm 5¾"
- 08.123.03 14,5 cm 5¾"



½

08.124.12	12 cm 4¾"	⌈	▲
08.125.12	12 cm 4¾"	⌋	▲
08.126.12	12 cm 4¾"	⌈	▲
08.127.12	12 cm 4¾"	⌋	▲



½

08.126.13	13 cm 5"	⌈	▲
08.127.13	13 cm 5"	⌋	▲



½

JOSEPH

08.304.14	14 cm 5½"	⌈	▲
08.305.14	14 cm 5½"	⌋	▲



½

JOSEPH

08.308.14	14 cm 5½"	⌈	▲	■
08.309.14	14 cm 5½"	⌋	▲	■



½

DEAVER

08.140.14	14 cm 5½"	⌈	▲
08.141.14	14 cm 5½"	⌋	▲



½

KELLY

08.540.16	16 cm 6¼"	⌈	▲	
08.541.16	16 cm 6¼"	⌋	▲	
08.542.16	16 cm 6¼"	⌈	▲	■
08.543.16	16 cm 6¼"	⌋	▲	■



½

SANVENERO

08.302.14	14 cm 5½"	⌈	▲
08.303.14	14 cm 5½"	⌋	▲

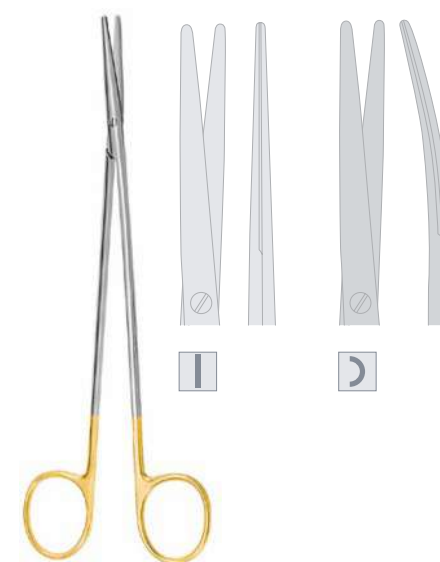
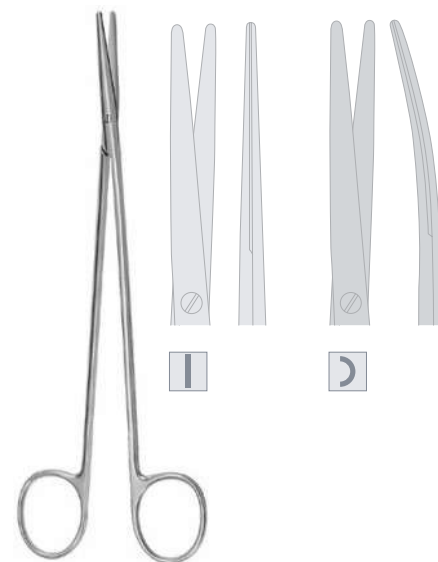

½

METZENBAUM

08.210.11	11,5 cm 4½"		
08.211.11	11,5 cm 4½"		
08.280.15	14,5 cm 5¾"		
08.281.15	14,5 cm 5¾"		
08.280.18	18 cm 7"		
08.281.18	18 cm 7"		

½

METZENBAUM

08.284.11	11,5 cm 4½"			
08.285.11	11,5 cm 4½"			
08.284.15	14,5 cm 5¾"			
08.285.15	14,5 cm 5¾"			
08.284.18	18 cm 7"			
08.285.18	18 cm 7"			

½

METZENBAUM-FINO

08.282.15	14,5 cm 5¾"		
08.283.15	14,5 cm 5¾"		

½

METZENBAUM-FINO

08.286.15	14,5 cm 5¾"			
08.287.15	14,5 cm 5¾"			

½

METZENBAUM-FINO

08.292.14	14,5 cm 5¾"		



½

METZENBAUM

08.278.14	14,5 cm 5¾"		
08.279.14	14,5 cm 5¾"		
08.288.14	14,5 cm 5¾"		
08.289.14	14,5 cm 5¾"		

½

LEXER-FINO

08.196.16	16,5 cm 6½"		
08.197.16	16,5 cm 6½"		

½

DE BAKEY

08.215.17	17,5 cm 7"		

Arteriotomie-Schere
arteriotomy scissors
ciseaux d'artériotomie
tijeras de arteriotomía
forbici da arteriotomia

½

METZENBAUM-FINO

08.293.14	14,5 cm 5¾"		
-----------	-------------	--	--

½

METZENBAUM-FINO

08.296.14	14,5 cm 5¾"			
-----------	-------------	--	--	--

½

METZENBAUM-FINO

08.297.14	14,5 cm 5¾"		





1/2

08.582.15 15 cm|6"  



1/2

08.583.15 15 cm|6"  

Nerv-Präparierschere
nerve dissecting scissors
ciseaux à préparation de nerf
tijeras para preparación del nervio
forbici per preparazione del nervo



1/2

TOENNIS-ADSON
08.609.17 17,5 cm|7"   



1/2

TOENNIS-ADSON
08.609.18 17,5 cm|7"   





1/2

TOENNIS-ADSON
08.613.17 17,5 cm|7"    



1/2

JAMESON-WERBER
08.584.13 13 cm|5"   





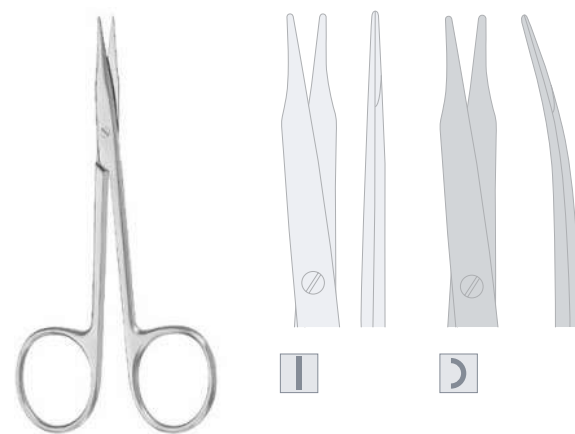

1/2

JAMESON
08.584.15 15 cm|6"   







1/2

08.306.11 11,5 cm|4 1/2"  
08.307.11 11,5 cm|4 1/2"  









1/2

KILNER
08.310.12 12 cm|4 3/4"  
08.310.15 15 cm|6"  







1/2

KILNER
08.314.12 12 cm|4 3/4"   
08.314.15 15 cm|6"   



1/2

REYNOLDS
08.321.15 15 cm|6"  
08.321.18 18 cm|7"  



IRISSCHEREN
 IRIS SCISSORS
 CISEAUX À IRIDECTOMIE
 TIJERAS PARA IRIDECTOMÍA
 FORBICI PER IRIDECTOMIA



½

IRIS

08.340.09	9 cm 3½"		
08.340.10	10,5 cm 4¼"		
08.340.11	11,5 cm 4½"		
08.340.12	12,5 cm 5"		



½

IRIS

08.341.09	9 cm 3½"		
08.341.10	10,5 cm 4¼"		
08.341.11	11,5 cm 4½"		
08.341.12	12,5 cm 5"		



½

IRIS

08.344.11	11,5 cm 4½"		



½

IRIS

08.345.11	11,5 cm 4½"		



½

IRIS

08.351.11	11,5 cm 4½"		
-----------	-------------	--	--



½

IRIS

08.353.11	11,5 cm 4½"		
-----------	-------------	--	--

ZAHNFLEISCHSCHEREN
 GUM SCISSORS
 CISEAUX À GENCVES
 TIJERAS PARA ENCÍAS
 FORBICI PER GENGVES



½

DEAN

08.317.17	17 cm 6¾"		



½

DEAN

08.425.17	17 cm 6¾"		



½

DEAN

08.427.17	17 cm 6¾"		



½

LOCKLIN

08.315.16	16 cm 6¼"					
-----------	-----------	--	--	--	--	--



½

LOCKLIN

08.317.16	16 cm 6¼"						
-----------	-----------	--	--	--	--	--	--



ZAHNFLEISCHSCHEREN
 GUM SCISSORS
 CISEAUX À GENCVES
 TIJERAS PARA ENCÍAS
 FORBICI PER GENGIVE

LIGATURSCHEREN
 LIGATURE SCISSORS
 CISEAUX À LIGATURE
 TIJERAS PARA LIGADURA
 FORBICI PER LEGATURA



½
GOLDMAN-FOX
 08.820.13 13 cm5"



½
GOLDMAN-FOX
 08.821.13 13 cm5"



½
GOLDMAN-FOX
 08.822.13 13 cm5"



½
SPENCER
 08.802.09 9 cm3½"

08.802.11 11 cm4¾"

08.802.12 12 cm4¾"



½
SHORTBENT
 08.803.09 9 cm3½"



½
NORTHBENT
 08.803.13 13 cm5"



½
GOLDMAN-FOX
 08.823.13 13 cm5"



½
WAGNER
 08.824.12 12 cm4¾"



½
WAGNER
 08.825.12 12 cm4¾"



½
LITTAUER
 08.804.14 14 cm5½"



½
BUCK
 08.806.14 14,5 cm5¾"

08.806.18 18 cm7"





½
EISELSBERG
 08.810.12 12 cm4¾"







DRAHTSCHEREN
WIRE CUTTING SCISSORS
CISEAUX À COUPER DU FIL DE FER
TIJERAS PARA CORTAR HILOS DE ACERO
FORBICI PER TAGILARE FILI METALLICO





1/2
UNIVERSAL
08.831.12 12 cml4 3/4"  





1/2
UNIVERSAL
08.835.12 12 cml4 3/4"   





1/2
BEEBEE
08.850.10 10,5 cml4"  





1/2
BEEBEE
08.851.10 10,5 cml4"  





1/2
BEEBEE
08.853.10 10,5 cml4"  



1/2
BEEBEE
08.854.12 12 cml4 3/4"   



1/2
BEEBEE
08.855.12 12 cml4 3/4"   







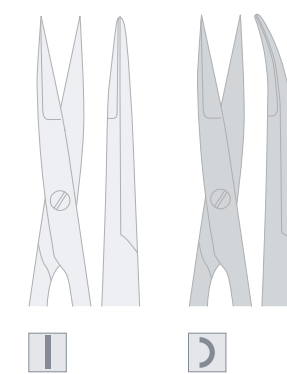









MIKROSCHEREN
MICRO SCISSORS
MICRO-CISEAUX
TIJERAS MICROQUIRÚRGICAS
FORBICI MICRO-CHIRURGICI























Rundgriff
round handle
manche rond
mango redondo
manico rotondo



Flachgriff
flat handle
manche plat
mango plano
manico piatto

- | | | |
|-----------|--------------|---|
| 09.710.15 | 15 cml6" |  |
| 09.711.15 | 15 cml6" |  |
| 09.720.15 | 15 cml6" |   |
| 09.721.15 | 15 cml6" |   |
| 09.710.18 | 18 cml7" |  |
| 09.711.18 | 18 cml7" |  |
| 09.720.18 | 18 cml7" |   |
| 09.721.18 | 18 cml7" |   |
| 09.710.21 | 21 cml8 1/4" |  |
| 09.711.21 | 21 cml8 1/4" |  |
| 09.720.21 | 21 cml8 1/4" |   |
| 09.721.21 | 21 cml8 1/4" |   |
| 09.710.23 | 23 cml9" |  |
| 09.711.23 | 23 cml9" |  |

- | | | |
|-----------|--------------|---|
| 09.712.15 | 15 cml6" |  |
| 09.713.15 | 15 cml6" |  |
| 09.722.15 | 15 cml6" |   |
| 09.723.15 | 15 cml6" |   |
| 09.712.18 | 18 cml7" |  |
| 09.713.18 | 18 cml7" |  |
| 09.722.18 | 18 cml7" |   |
| 09.723.18 | 18 cml7" |   |
| 09.712.21 | 21 cml8 1/4" |  |
| 09.713.21 | 21 cml8 1/4" |  |
| 09.722.21 | 21 cml8 1/4" |   |
| 09.723.21 | 21 cml8 1/4" |   |
| 09.712.23 | 23 cml9" |  |
| 09.713.23 | 23 cml9" |  |



VERBANDSSCHEREN
BANDAGE SCISSORS
CISEAUX À BANDAGES
TIJERAS PARA VENDAJES
FORBICI PER BENDAGGI



¼

LISTER

08.901.11	11 cm 4¼"	
08.901.14	14 cm 5½"	
08.901.16	16 cm 6¼"	
08.901.18	18 cm 7"	
08.901.20	20 cm 8"	



½

UNIVERSAL

08.950.15	15 cm 6"		
08.950.15B	15 cm 6"		
08.950.15G	15 cm 6"		
08.950.15R	15 cm 6"		
08.950.15Y	15 cm 6"		
08.950.15W	15 cm 6"		
08.950.18	18 cm 7"		
08.950.18B	18 cm 7"		
08.950.18G	18 cm 7"		
08.950.18R	18 cm 7"		
08.950.18Y	18 cm 7"		
08.950.18W	18 cm 7"		

04

- PINZETTEN
- FORCEPS
- PINCES
- PINZAS
- PINZE





PINZETTEN
 DISSECTING AND TISSUE FORCEPS
 PINCES À DISSECTION
 PINZAS DE DISECCIÓN
 PINZE PER DISSEZIONE

PINZETTEN
 DISSECTING AND TISSUE FORCEPS
 PINCES À DISSECTION
 PINZAS DE DISECCIÓN
 PINZE PER DISSEZIONE

04



1/2
ADSON
 10.170.12 12 cm 4 3/4"



1/2
ADSON
 10.174.12 12 cm 4 3/4" 0,5



1/2
ADSON
 10.180.12 12 cm 4 3/4" 1:2



1/2
 10.102.13 13 cm 5"

10.102.14 14,5 cm 5 3/4"



1/2
 10.110.13 13 cm 5"

10.110.14 14,5 cm 5 3/4"



1/2
 10.114.14 14,5 cm 5 3/4" 0,5

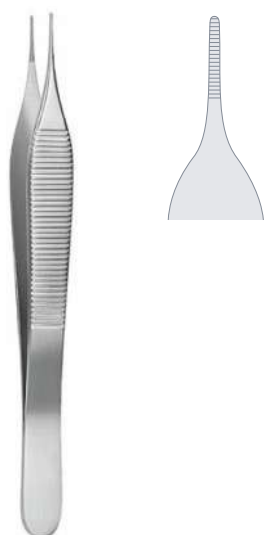

1/2
ADSON micro
 10.176.12 12 cm 4 3/4"



1/2
ADSON micro
 10.186.12 12 cm 4 3/4" 1:2

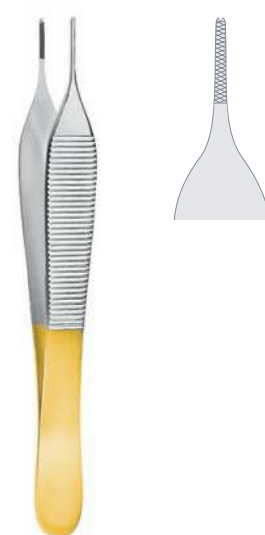

1/2
ADSON micro
 10.173.12 12 cm 4 3/4" 0,4 1:2



1/2
 10.120.13 13 cm 5" 1:2

10.120.14 14,5 cm 5 3/4" 1:2



1/2
 10.130.13 13 cm 5" 1:2

10.130.14 14,5 cm 5 3/4" 1:2



PINZETTEN
 DISSECTING AND TISSUE FORCEPS
 PINCES À DISSECTION
 PINZAS DE DISECCIÓN
 PINZE PER DISSEZIONE

PINZETTEN
 DISSECTING AND TISSUE FORCEPS
 PINCES À DISSECTION
 PINZAS DE DISECCIÓN
 PINZE PER DISSEZIONE

04



1/2
CUSHING
 10.220.17 17 cm 6 3/4"



1/2
CUSHING
 10.230.17 17 cm 6 3/4"  1:2



1/2
CUSHING
 10.224.17 17 cm 6 3/4" 0,5 



1/2
TAYLOR
 10.274.17 17 cm 6 3/4"



1/2
TAYLOR
 10.276.17 17,5 cm 7"  1:2



1/2
BROPHY
 10.290.20 20 cm 8"  1:2



1/2
SEMKEN
 10.260.12 12,5 cm 5"
 10.260.15 15,5 cm 6"



1/2
SEMKEN
 10.270.12 12,5 cm 5"
 10.270.15 15,5 cm 6"  1:2



1/2
GILLIES
 10.272.15 15,5 cm 6"  1:2





1/2
BROPHY
 10.288.20 20 cm 8"



1/2
GERALD
 10.302.18 18 cm 7" 



1/2
GERALD
 10.310.18 18 cm 7"   1:2



PINZETTEN
DISSECTING AND TISSUE FORCEPS
PINCES À DISSECTION
PINZAS DE DISECCIÓN
PINZE PER DISSEZIONE

Uhrmacherpinzette
watchmaker forcep
pince d'horloger
pinza de relojero
pinza da orologiaio

Nahtpinzetten
suturing forceps
pinces à sutures
pinzas para suturas
pinze per legature



10.330.12	12 cml4¾"	10.346.15	15 cml6"	10.348.15	15 cml6"	10.349.15	15 cml6"
-----------	-----------	-----------	----------	-----------	----------	-----------	----------

Splitterzangen
splinter forceps
pinces à échardes
pinzas para espinas
pinze per scheggie



10.821.11	11,5 cml4¼"	10.822.13	13,5 cml5¼"	10.823.13	13,5 cml5¼"	45°	10.828.15	15 cml6"
		10.823.90	13,5 cml5¼"			90°		

ATRAUMISCHE PINZETTEN
ATRAUMATIC TISSUE FORCEPS
PINCES ATRAUMATIQUES
PINZAS ATRAUMÁTICAS
PINZE ATRAUMATICHE

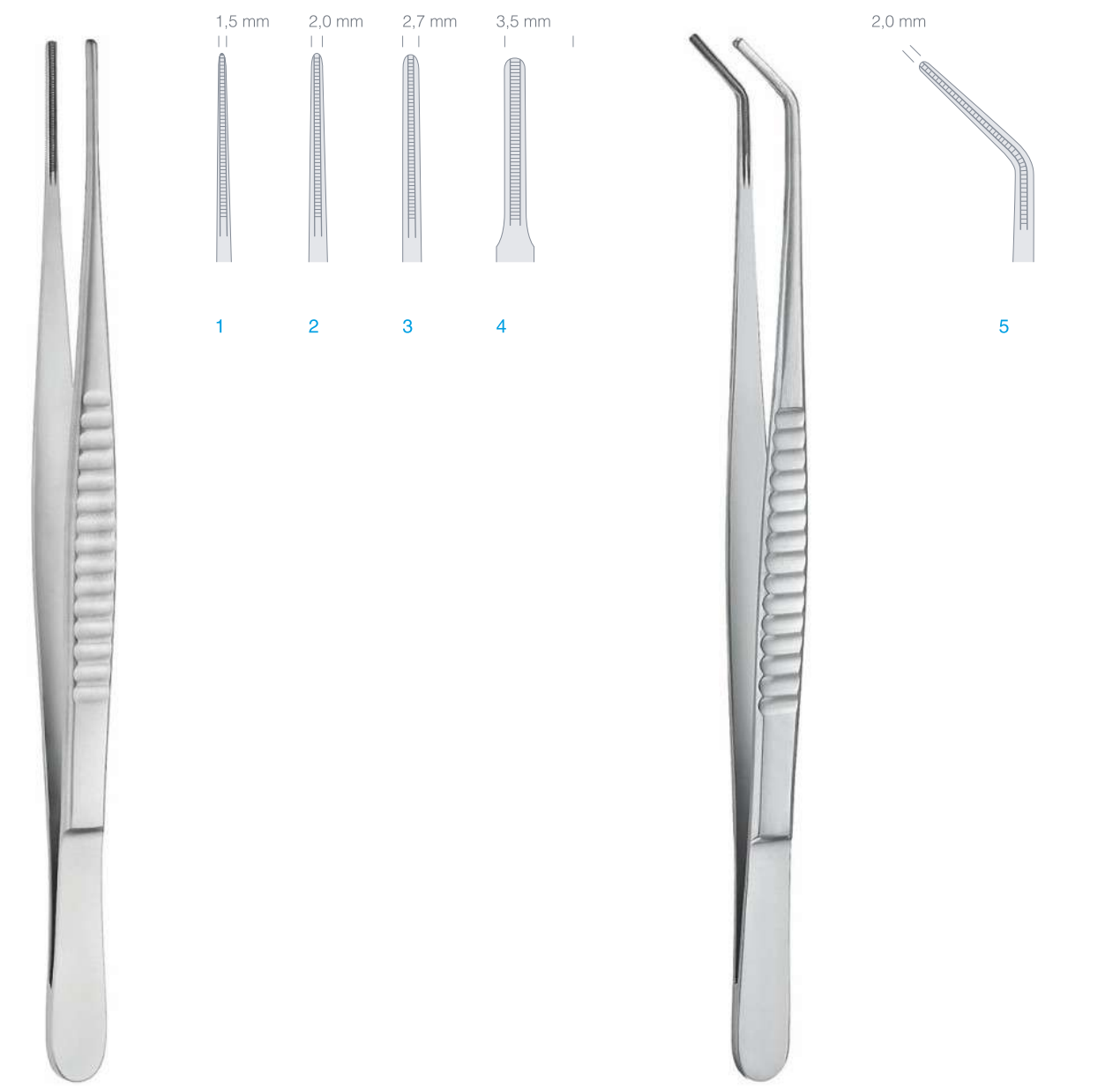

11.304.16	16 cml6¼"	3	11.309.16	16 cml6¼"	5
11.304.20	20 cml8"	3	11.309.20	20 cml8"	5
11.306.16	16 cml6¼"	1			
11.306.20	20 cml8"	1			
11.308.16	16 cml6¼"	2			
11.308.20	20 cml8"	2			
11.334.15	15 cml6"	4			

ZAHNPINZETTEN
DENTAL TWEEZERS
PRÉCELLES POUR COTON
PINZAS DENTAL
PINZE DENTALE

ZAHNPINZETTEN
DENTAL TWEEZERS
PRÉCELLES POUR COTON
PINZAS DENTAL
PINZE DENTALE

passend für
for
allant avec
para
per
LONDON-COLLEGE

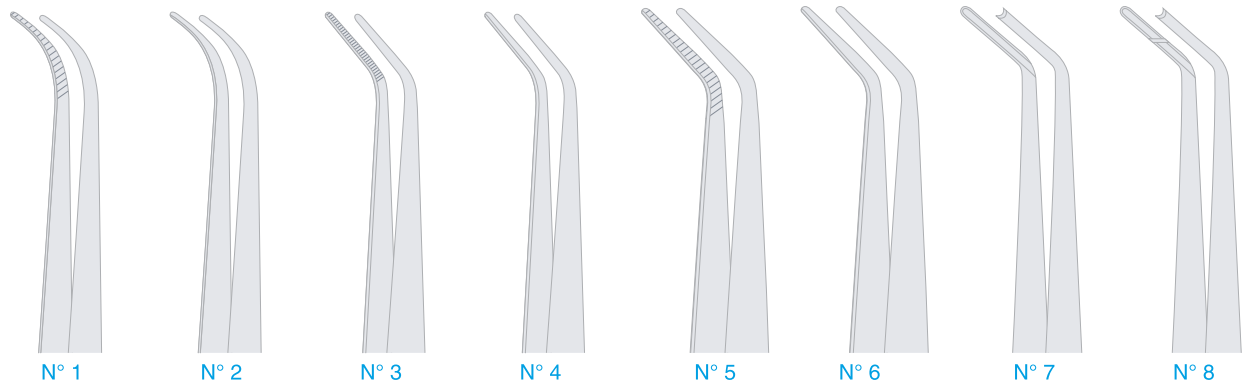

passend für
for
allant avec
para
per
MERIAM

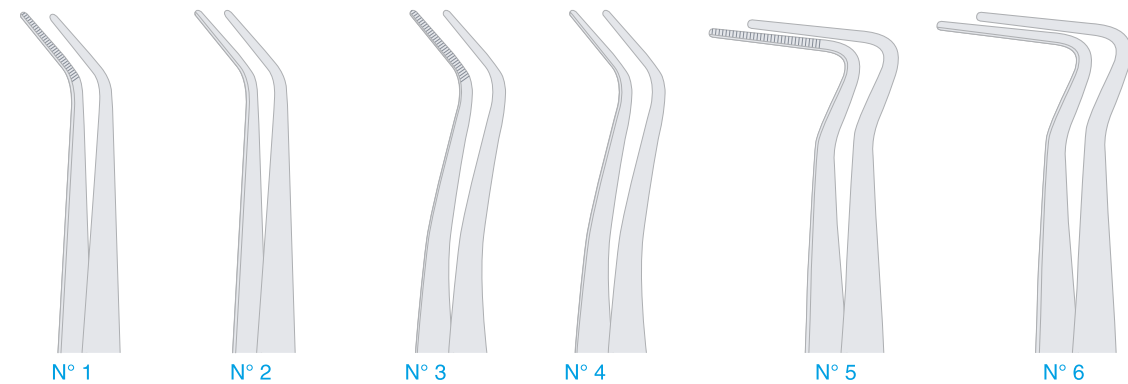

1/4
LONDON-COLLEGE

83.029.01	15 cml6"	N° 1		
83.029.03	15 cml6"	N° 3		
83.029.05	15 cml6"	N° 5		

1/4
LONDON-COLLEGE

83.031.01	15 cml6"	N° 1	
83.031.02	15 cml6"	N° 2	
83.031.03	15 cml6"	N° 3	
83.031.04	15 cml6"	N° 4	
83.031.05	15 cml6"	N° 5	
83.031.06	15 cml6"	N° 6	
83.031.07	15 cml6"	N° 7	
83.031.08	15 cml6"	N° 8	

1/4
LONDON-COLLEGE

83.033.01	15 cml6"	N° 1	
83.033.02	15 cml6"	N° 2	
83.033.03	15 cml6"	N° 3	
83.033.04	15 cml6"	N° 4	
83.033.05	15 cml6"	N° 5	
83.033.06	15 cml6"	N° 6	
83.033.07	15 cml6"	N° 7	
83.033.08	15 cml6"	N° 8	

1/4
LONDON-COLLEGE

83.037.01	15 cml6"	N° 1	
83.037.02	15 cml6"	N° 2	
83.037.03	15 cml6"	N° 3	
83.037.04	15 cml6"	N° 4	
83.037.05	15 cml6"	N° 5	
83.037.06	15 cml6"	N° 6	
83.037.07	15 cml6"	N° 7	
83.037.08	15 cml6"	N° 8	

1/4
MERIAM

83.099.01	16 cml6 1/4"	N° 1	
83.099.03	16 cml6 1/4"	N° 3	
83.099.05	16 cml6 1/4"	N° 5	

1/4
MERIAM

83.101.01	16 cml6 1/4"	N° 1	
83.101.02	16 cml6 1/4"	N° 2	
83.101.03	16 cml6 1/4"	N° 3	
83.101.04	16 cml6 1/4"	N° 4	
83.101.05	16 cml6 1/4"	N° 5	
83.101.06	16 cml6 1/4"	N° 6	

ZAHNPINZETTEN
DENTAL TWEEZERS
PRÉCELLES POUR COTON
PINZAS DENTAL
PINZE DENTALE

ZAHNPINZETTEN
DENTAL TWEEZERS
PRÉCELLES POUR COTON
PINZAS DENTAL
PINZE DENTALE

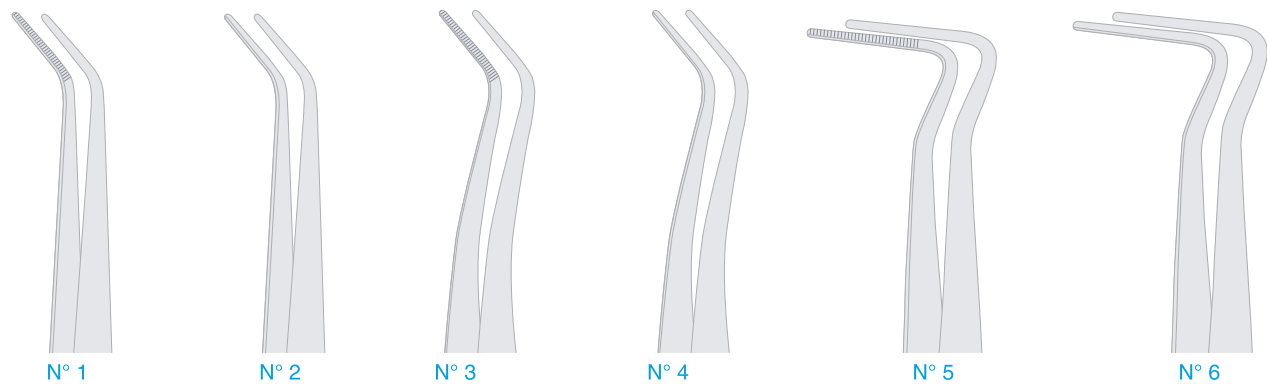

1/4
MERIAM

83.103.01	16 cm/6 1/4"	N° 1	Y
83.103.02	16 cm/6 1/4"	N° 2	
83.103.03	16 cm/6 1/4"	N° 3	
83.103.04	16 cm/6 1/4"	N° 4	
83.103.05	16 cm/6 1/4"	N° 5	
83.103.06	16 cm/6 1/4"	N° 6	

1/4
FLAGG

83.107.01	16 cm/6 1/4"	N° 1	Y
83.107.02	16 cm/6 1/4"	N° 2	
83.107.03	16 cm/6 1/4"	N° 3	
83.107.04	16 cm/6 1/4"	N° 4	

1/4
FLAGG

83.109.01	16 cm/6 1/4"	N° 1	Y
83.109.02	16 cm/6 1/4"	N° 2	
83.109.03	16 cm/6 1/4"	N° 3	
83.109.04	16 cm/6 1/4"	N° 4	

1/4
LANDGRAF

83.115.03	15 cm/6"	1	Y
83.115.04	15 cm/6"	2	

1/4
PERRY

83.120.12	12,5 cm/5"		
-----------	------------	--	--

1/4
PERRY

83.121.12	12,5 cm/5"		D
-----------	------------	--	---



1/1
MERIAM USA
83.133.17 17 cm|6 3/4"



1/1
LONDON-COLLEGE modified
83.141.15 15 cm|6"



1/1
CRANE-KAPLAN
83.343.01 15 cm|6" 1
83.343.02 15 cm|6" 2

Markierpinzetten
pocket markers
pinces pour marquer
pinzas para marcar
pinze per marcare

05

- ARTERIENKLEMMEN
HEMOSTATIC FORCEPS
PINCES HÉMOSTATIQUES
PINZAS HEMOSTÁTICAS
PINZE EMOSTATICHE

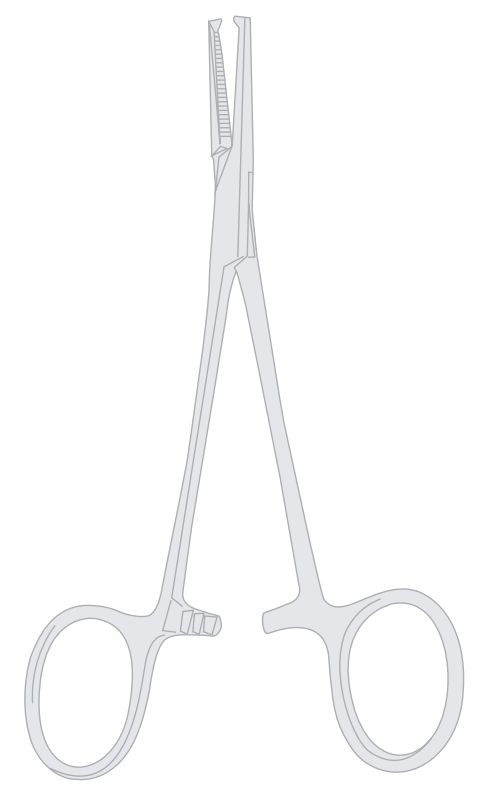



ARTERIENKLEMMEN
HEMOSTATIC FORCEPS
PINCES HÉMOSTATIQUES
PINZAS HEMOSTÁTICAS
PINZE EMOSTATICHE

ARTERIENKLEMMEN
HEMOSTATIC FORCEPS
PINCES HÉMOSTATIQUES
PINZAS HEMOSTÁTICAS
PINZE EMOSTATICHE



½

HALSTED-MOSQUITO

12.220.12 12,5 cm5"

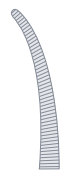

½

HALSTED-MOSQUITO

12.221.12 12,5 cm5"



½

HALSTED-MOSQUITO

12.230.12 12,5 cm5"



1:2



½

KELLY-RANKIN

12.242.16 16 cm6¼"



½

KELLY-RANKIN

12.243.16 16 cm6¼"

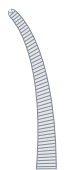

½

HALSTED-MOSQUITO

12.231.12 12,5 cm5"



1:2



½

KELLY

12.240.14 14 cm5½"



½

KELLY

12.241.14 14 cm5½"



½

CRILE

12.250.14 14 cm5½"



½

CRILE

12.251.14 14 cm5½"





ARTERIENKLEMMEN
HEMOSTATIC FORCEPS
PINCES HÉMOSTATIQUES
PINZAS HEMOSTÁTICAS
PINZE EMOSTATICHE

ARTERIENKLEMMEN
HEMOSTATIC FORCEPS
PINCES HÉMOSTATIQUES
PINZAS HEMOSTÁTICAS
PINZE EMOSTATICHE



1/2
PROVIDENCE-HOSPITAL
12.270.14 14 cm 5 1/2"



1/2
PROVIDENCE-HOSPITAL
12.271.14 14 cm 5 1/2"



1/2
PEAN
12.368.14 14 cm 5 1/2"



1/2
ROCHESTER-OCHSNER
12.320.14 14 cm 5 1/2" 1:2



1/2
ROCHESTER-OCHSNER
12.321.14 14 cm 5 1/2" 1:2



1/2
ROCHESTER-PEAN
12.310.14 14 cm 5 1/2"



1/2
ROCHESTER-PEAN
12.311.14 14 cm 5 1/2"

Tuchklemmen
towel clamps
pinces à champs
pinzas de campo
pinze di campo



1/2
SCHAEDEL
14.101.09 9 cm 3 1/2"



1/2
BACKHAUS
14.111.09 9 cm 3 1/2"
14.111.11 11 cm 4 1/4"



1/2
14.123.11 11 cm 4 1/4"
14.123.13 13 cm 5"
14.123.14 14 cm 5 1/2"



GEWEBEFASSZANGEN
 TISSUE GRASPING FORCEPS
 PINCES À TISSUS
 PINZAS PARA TEJIDOS
 PINZE PER TESSUTI



½

ALLIS-BABY

64.102.14 14 cm 5½"



4:5



½

ALLIS

64.110.15 15 cm 6"



4:5

64.120.15 15 cm 6"



5:6

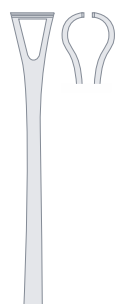

½

BABCOCK

64.160.16 16 cm 6¼"

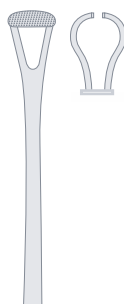

½

BABCOCK

64.164.16 16 cm 6¼"

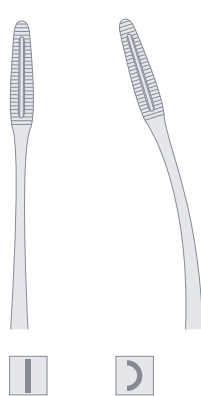

½

GROSS-MAIER

16.110.20 20 cm 8"



16.111.20 20 cm 8"



06

- WUNDHAKEN
 RETRACTORS
 ÉCARTEURS
 SEPARADORES
 DIVARICATORI





WUNDHAKEN
RETRACTORS
ÉCARTEURS
SEPARADORES
DIVARICATORI

N° 1 = 26 x 10 mm
N° 2 = 30 x 10 mm

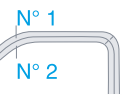

N° 1 = 30 x 13 mm
N° 2 = 34 x 13 mm

½

FARABEUF

18.102.12 12 cml5¾"

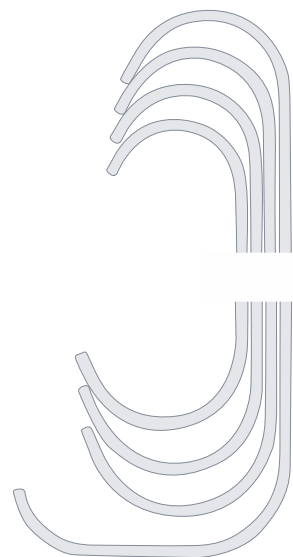

½

ROUX

18.120.00 set N° 1-3

18.120.14 14 cml5½" 24 x 20 mm | 30 x 28 mm N° 1

18.120.15 15 cml6" 29 x 26 mm | 36 x 36 mm N° 2

18.120.17 17 cml6¾" 33 x 29 mm | 38 x 43 mm N° 3

18.120.18 18 cml7" 29 x 24 mm | 45 x 28 mm N° 4

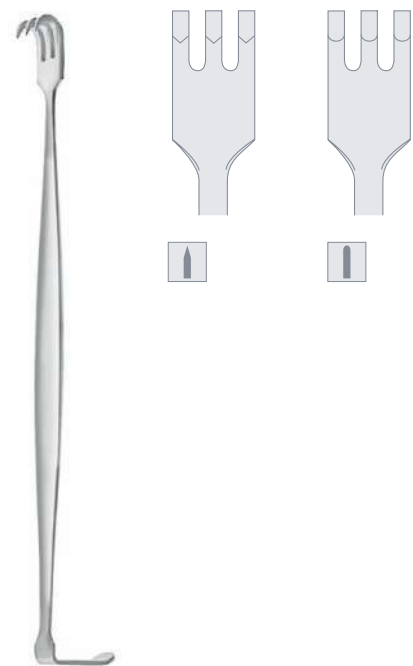

½

SENN

18.160.17 17 cml6¾"

18.161.17 17 cml6¾"

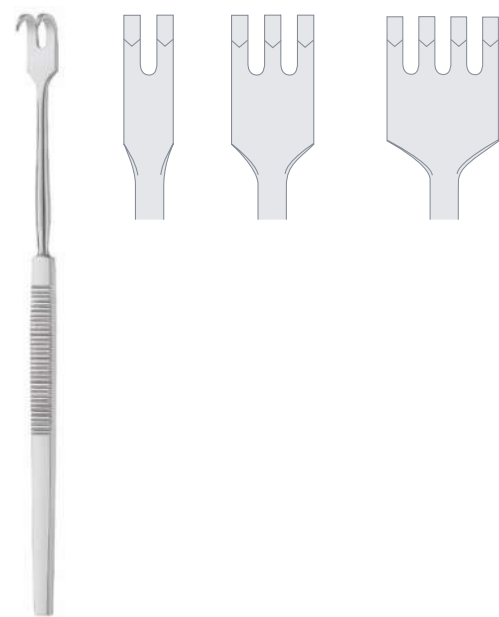

½

18.220.02 16 cml6¼"

18.220.03 16 cml6¼"

18.220.04 16 cml6¼"

WUNDHAKEN
RETRACTORS
ÉCARTEURS
SEPARADORES
DIVARICATORI



Nasenflügelhäkchen
alar hooklet
crochet pour ailes de nez
ganchito para alas de nariz
uncino per le pinne nasali

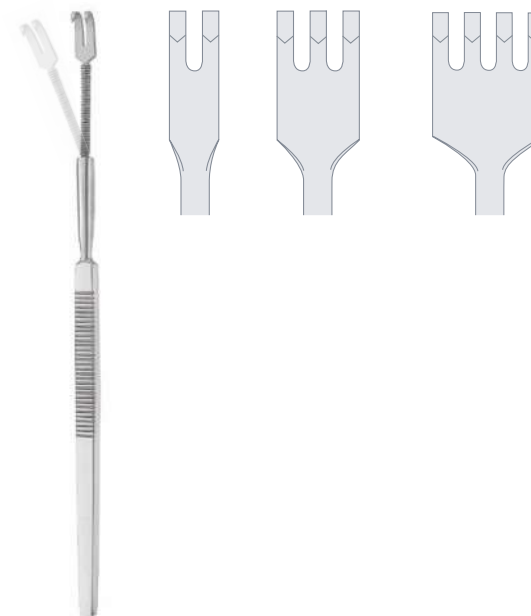

½

18.226.02 16 cml6¼"

18.226.03 16 cml6¼"

18.226.04 16 cml6¼"



½

GILLIES

46.560.18 18 cml7"



½

GILLIES

46.562.18 18 cml7"

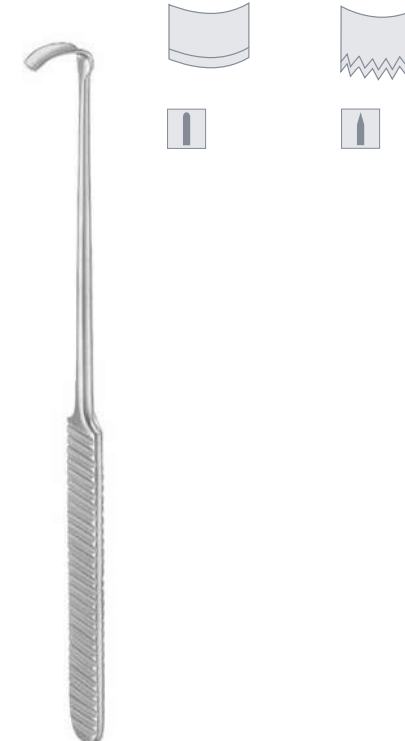

½

STRANDELL-STILLE

18.228.08 19 cml7½"

18.228.09 19 cml7½"



½

VOLKMANN

18.281.03 21,5 cml8½"



½

VOLKMANN

18.281.04 21,5 cml8½"

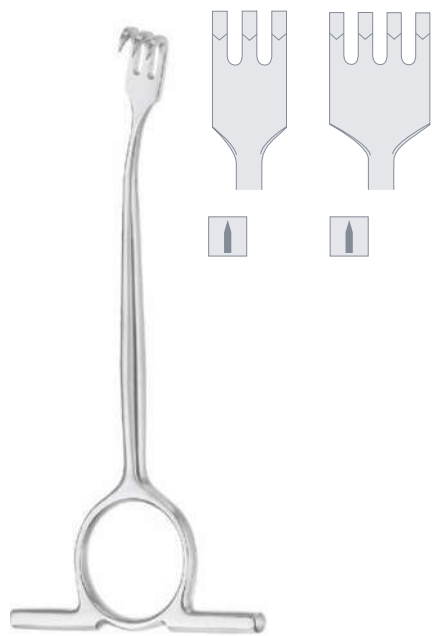
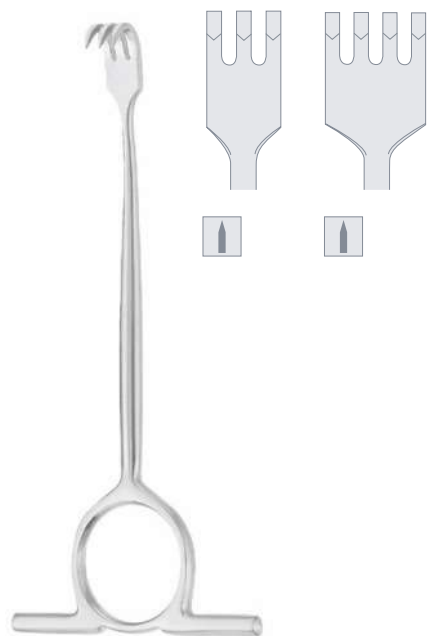
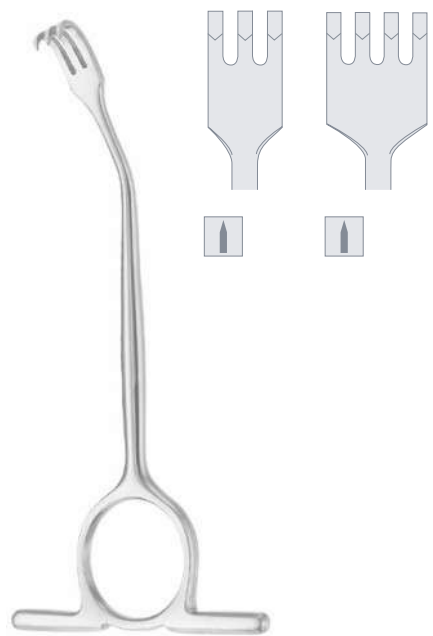

½

WILLIGER

18.250.03 12,5 cm 5"

18.250.04 12,5 cm 5"

½

WILLIGER

18.252.03 12,5 cm 5"

18.252.04 12,5 cm 5"

½

WILLIGER

18.254.03 12,5 cm 5"

18.254.04 12,5 cm 5"

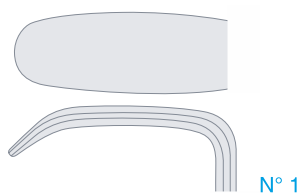

N° 1

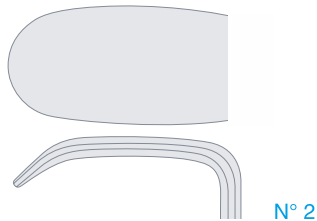

N° 2

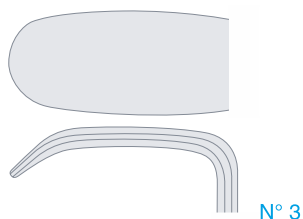

N° 3

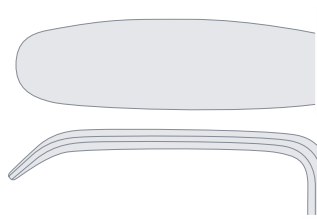

N° 4

½

LANGENBECK

18.310.01 22 cm 8¾" 30 x 11 mm N° 1

18.310.02 22 cm 8¾" 30 x 14 mm N° 2

18.310.03 22 cm 8¾" 30 x 16 mm N° 3

18.310.04 22 cm 8¾" 40 x 11 mm N° 4

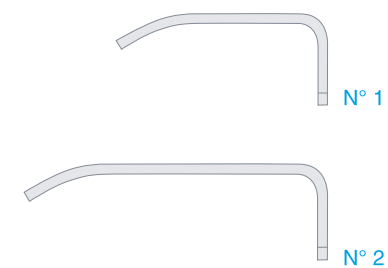

N° 1

N° 2

½

KOCHER-LANGENBECK

18.342.05 22 cm 8¾" 40 x 11 mm N° 1

18.342.06 22 cm 8¾" 55 x 11 mm N° 2



½

KOCHER-LANGENBECK

18.354.21 21 cm 8¼" 23 x 8 mm



½

GREEN

18.348.22 22,5 cm 8¾" 22 x 22 mm

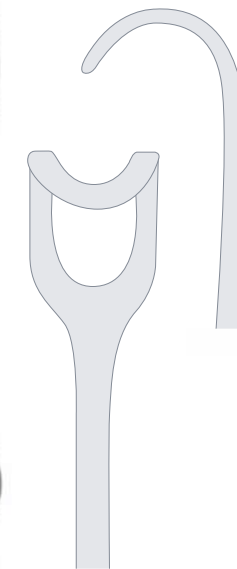

N° 1

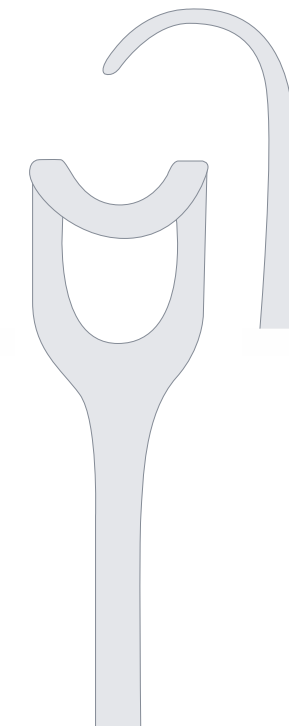

N° 2

½

MIDDELDORFF

18.344.14 21,5 cm 8½" 14 x 17 mm N° 1

18.344.20 22 cm 8¾" 20 x 22 mm N° 2



Kinnhalter
chin retractor
écarteur pour menton
separador para mentón
divaricatore per il mento



- ½
OBWEGESER
- 48.599.30 30 x 9|12 mm
 - 48.599.45 45 x 9|12 mm
 - 48.599.60 60 x 9|12 mm

- ½
OBWEGESER
- 48.601.16 16 cm|6¼"



- ½
OBWEGESER
- 48.593.40 11 x 40 mm
 - 48.593.55 11 x 55 mm
 - 48.593.80 16 x 80 mm



- ½
WARD
- 48.590.15 15,5 cm|6"



- ½
48.235.19 19 cm|7½"



- ½
BOWDLER-HENRY
- 48.590.70 16 cm|6¼"



- ½
KAY (AUSTIN)
- 48.590.73 80 mm



WUNDSPREIZER
 SELF-RETAINING RETRACTORS
 ÉCARTEURS AUTOSTATIQUES
 SEPARADORES AUTOESTÁTICOS
 DIVARICATORI AUTOSTATICI

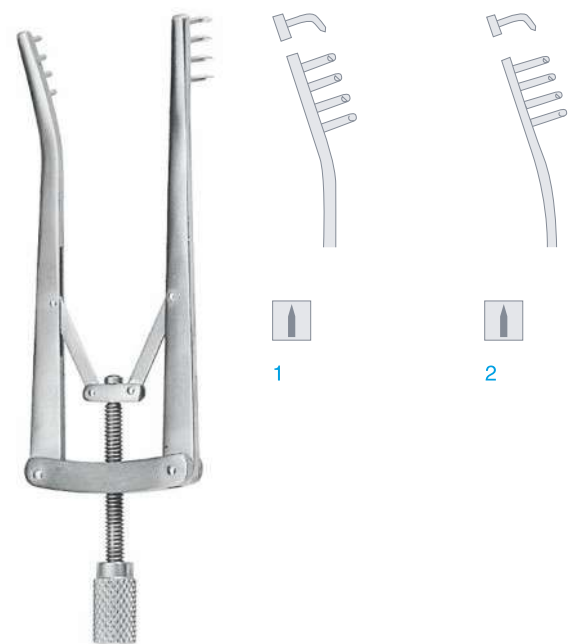

1



2

½

ALM

18.620.07	7 cm 2¾"	1	
-----------	----------	---	--

18.620.10	10 cm 4"	2	
-----------	----------	---	--



½

WEITLANER

18.670.14	13 cm 5"		
-----------	----------	--	--

18.671.14	13 cm 5"		
-----------	----------	--	--

07

- NADELHALTER
- NEEDLE HOLDERS
- PORTE-AIGUILLES
- PORTA-AGUJAS
- PORT'AGHI

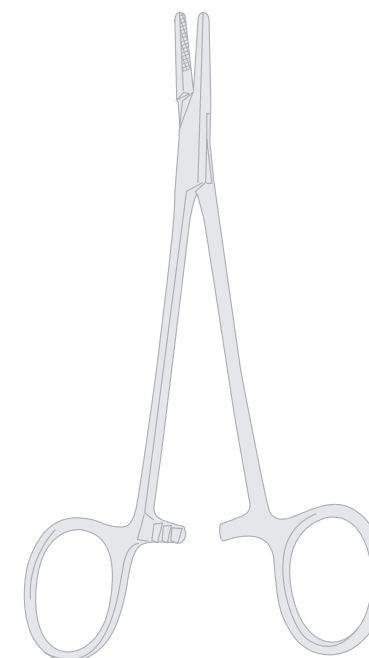



NADELHALTER
NEEDLE HOLDERS
PORTE-AIGUILLES
PORTA-AGUJAS
PORT'AGHI

NADELHALTER
NEEDLE HOLDERS
PORTE-AIGUILLES
PORTA-AGUJAS
PORT'AGHI



½
HALSEY

24.130.13	13 cm 5"	1
24.140.13	13 cm 5"	2



½
HALSEY

24.134.13	13 cm 5"	1	0,4	■
24.144.13	13 cm 5"	2	0,4	■



½
BAUMGARTNER

24.150.12	12,5 cm 5"
24.150.14	14 cm 5½"



½
CRILE-MURRAY

24.170.15	15 cm 6"	I
-----------	----------	---



½
CRILE-MURRAY

24.174.15	15 cm 6"	0,4	■
		I	



½
MAYO-HEGAR

24.180.16	16 cm 6¼"
24.180.18	18 cm 7"



½
BAUMGARTNER

24.154.12	12,5 cm 5"	0,5	■
24.154.14	14 cm 5½"	0,5	■



½
CRILE-WOOD

24.160.15	15 cm 6"
-----------	----------



½
CRILE-WOOD

24.164.15	15 cm 6"	0,4	■
-----------	----------	-----	---



½
MAYO-HEGAR

24.184.16	16 cm 6¼"	0,5	■
24.184.18	18 cm 7"	0,5	■



½
MAYO-HEGAR

24.194.18	18 cm 7"	0,4	■
		I	



½
DE BAKEY

24.214.18	18 cm 7"	0,4	■
-----------	----------	-----	---



NADELHALTER
NEEDLE HOLDERS
PORTE-AIGUILLES
PORTA-AGUJAS
PORT'AGHI

NADELHALTER
NEEDLE HOLDERS
PORTE-AIGUILLES
PORTA-AGUJAS
PORT'AGHI

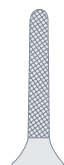

½
RYDER
24.224.15 15 cm 6"
24.224.18 18 cm 7"



½
RYDER Vascular
24.226.15 15,5 cm 6"
24.226.18 18 cm 7"



½
MATHIEU
24.280.14 14 cm 5½"
24.280.18 18 cm 7"



½
MATHIEU
24.370.14 14 cm 5½"
24.370.17 17 cm 6¾"



½
MATHIEU
24.374.14 14 cm 5½"
24.374.17 17 cm 6¾"



½
MATHIEU
24.390.14 14 cm 5½"
24.390.17 17 cm 6¾"



½
TOENNIS
24.360.18 18 cm 7"



½
TOENNIS
24.364.18 18 cm 7"



½
MATHIEU
24.386.20 20 cm 8"



½
MATHIEU
24.394.14 14 cm 5½"
24.394.17 17 cm 6¾"

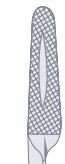

½
OLSEN-HEGAR
24.410.14 14 cm 5½"
24.410.18 18 cm 7"



½
OLSEN-HEGAR
24.414.14 14 cm 5½"
24.414.18 18 cm 7"



NADELHALTER
NEEDLE HOLDERS
PORTE-AIGUILLES
PORTA-AGUJAS
PORT'AGHI

MIKRO-NADELHALTER
MICRO NEEDLE HOLDERS
PORTE-AIGUILLES, MICRO
PORTA-AGUJAS, MICRO
PORT'AGHI, MICRO



1/2
OLSEN-HEGAR
24.420.17 17 cm 6 3/4"



1/2
OLSEN-HEGAR
24.424.17 17 cm 6 3/4" 0,5



1/2
STEVENS
24.612.13 13 cm 5"
24.612.15 15 cm 6"

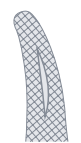

1/2
GILLES
24.430.16 16 cm 6 1/4"



1/2
GILLES
24.434.16 16 cm 6 1/4" 0,5



1/2
ARRUGA
24.620.16 16 cm 6 1/4"



1/2
ARRUGA
24.624.16 16 cm 6 1/4" 0,4



1/4
CASTROVIEJO
24.670.14 14 cm 5 1/2"

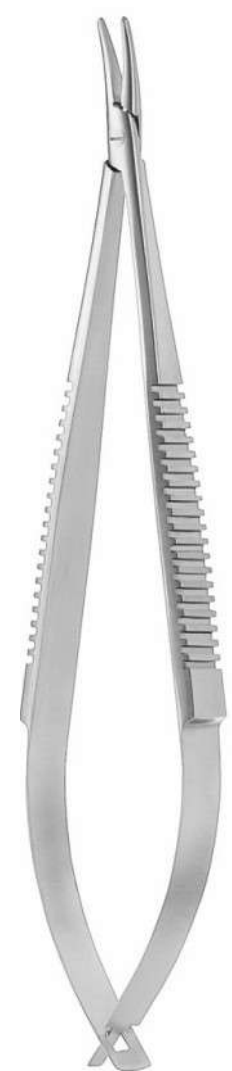

1/4
CASTROVIEJO
24.677.14 14 cm 5 1/2"





1/4
CASTROVIEJO
24.679.14 17 cm 6 3/4" 0,3



MIKRO-NADELHALTER
 MICRO NEEDLE HOLDERS
 PORTE-AIGUILLES, MICRO
 PORTA-AGUJAS, MICRO
 PORT'AGHI, MICRO







1/1

24.778.14 14 cm 5 1/2" 0,3  



1/1

24.920.15 15 cm 6"    

08

- ORTHOPÄDIE
- ORTHOPAEDICS
- ORTHOPÉDIE
- ORTOPEDIA
- ORTOPEDIA



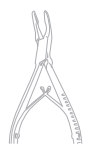

½
FRIEDMAN-MINI
32.101.12 12 cm 4¾"



½
FRIEDMAN
32.101.14 14 cm 5½"



½
FRIEDMAN
32.102.14 14 cm 5½"



½
CLEVELAND
32.106.15 15 cm 6"



½
MEAD
32.107.16 16 cm 6¼"



½
MEAD
32.109.16 16,5 cm 6½"

Knochensplitterzange
bone cutting forcep
pince coupante à os
pinzas cortante para hueso
cesoie per ossa

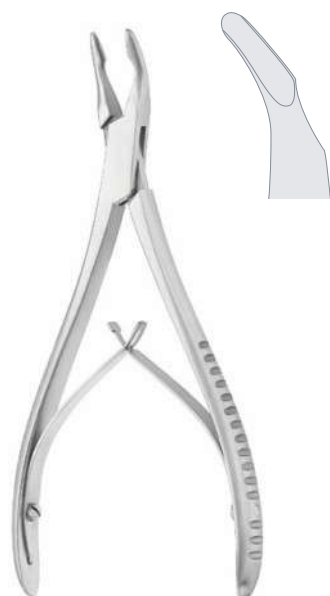

½
FRIEDMAN
32.102.15 15 cm 6"



½
CLEVELAND
32.103.14 14 cm 5½"



½
CLEVELAND
32.105.17 17 cm 6¾"

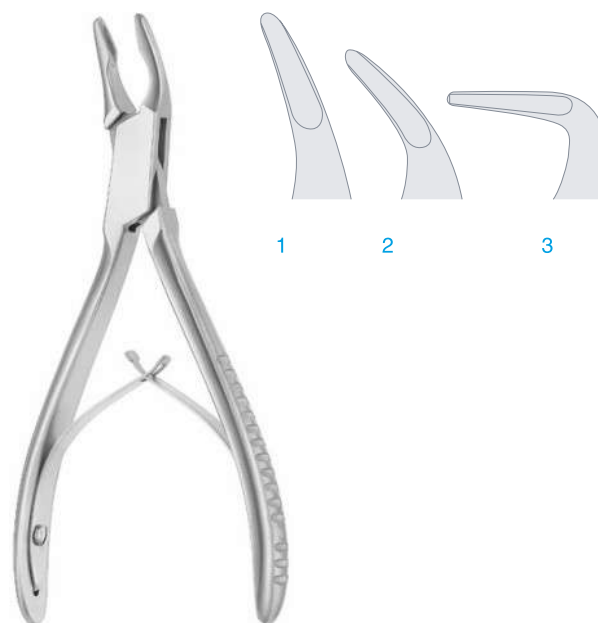

½
BLUMENTHAL

32.115.15	15,5 cm 6"	30°	1
32.117.15	15,5 cm 6"	45°	2
32.119.15	15,5 cm 6"	90°	3

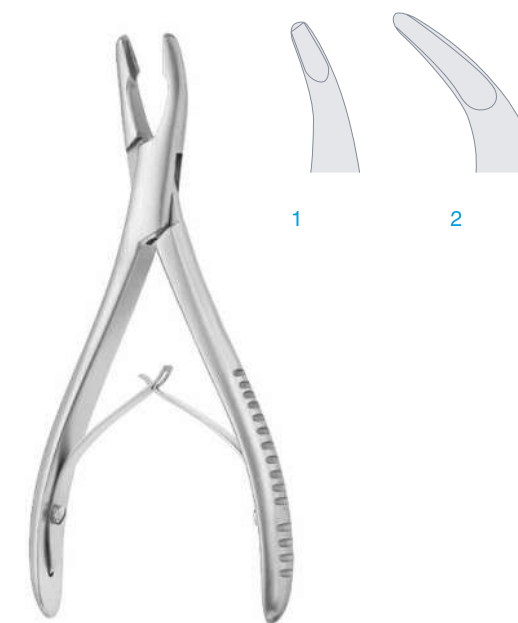

½
LUER

32.131.15	15 cm 6"	1
32.133.15	15 cm 6"	2



HOHLMEISSELZANGEN
BONE RONGEURS
PINCES-GOUGES
PINZAS-GUBIAS
PINZE SGORBIE

KNOCHENHALTEZANGEN
BONE HOLDING FORCEPS
DAVIERS À OS
PINZAS PARA HUESOS
TENAGLIE PER OSSA



½

BEYER

32.201.18 18 cm|7"



½

BOEHLER

32.210.15	15 cm 6"	1
32.213.15	15 cm 6"	2

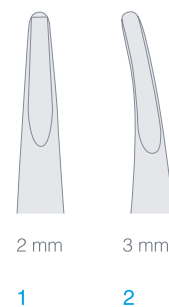

½

32.386.20 20 cm|8"



½

DINGMANN

32.407.19 19 cm|7½"



½

RUSKIN

32.216.18	18 cm 7"	1
32.217.18	18 cm 7"	2

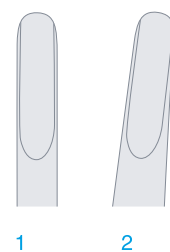

½

32.409.13 13,5 cm|5¼"

lange Sperre
long ratchet
cremaillère longue
cremallera larga
cremagliera lunga



½

ADSON

33.391.15 15 cm|6"

mit Bohrführung
with drill guide
avec guide de perçage
guía para perforación
con guida per trapano





HÄMMER
MALLETS
MARTEAUX
MARTILLOS
MARTELLI



1/2

MEAD

32.696.32 17 cm 6 3/4" ø 27 mm 320 g

32.697.02

Ersatzbacken-Paar aus Kunststoff
plastic replacement discs
plaques de rechange en plastique
tapas de repuesto de plástico
disco di ricambio plastico

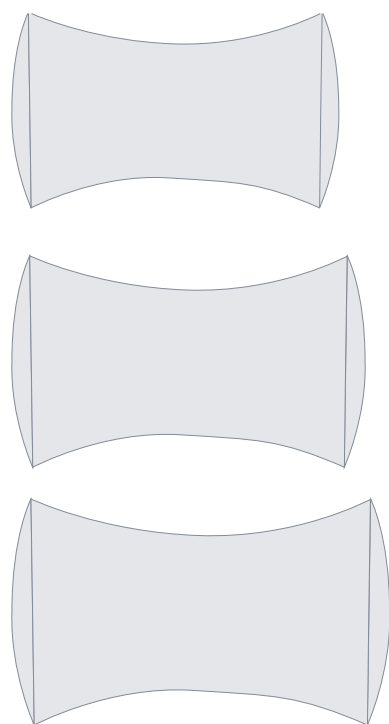

WILLIGER

32.694.30 24 cm 9 1/2" ø 26 mm 300 g

32.694.34 24 cm 9 1/2" ø 28 mm 340 g

32.694.40 24 cm 9 1/2" ø 30 mm 400 g

bleigefüllt
lead filled
rempli de plomb
relleno de plomo
ripieno di piombo

HÄMMER
MALLETS
MARTEAUX
MARTILLOS
MARTELLI



Niethammer mit breiter Pinne
riveting hammer wide edge
marteau à rivets avec large panne
martillo para remachar con peña ancha
martello per ribadire a bordo largo

Hornhammer
horn mallet
marteau à corne
martillo córneo
martello a corno



1/2

87.102.21 21,5 cm 8 1/2"



1/2

87.110.24 25 cm 10"



1/2

87.114.21 21,5 cm 8 1/2"



SCHARFE LÖFFEL
BONE CURETTES
CURETTES TRANCHANTES
CUCHARILLAS CORTANTES
CURETTE TAGLIENTI

SCHARFE LÖFFEL
BONE CURETTES
CURETTES TRANCHANTES
CUCHARILLAS CORTANTES
CURETTE TAGLIENTI



N° 0



N° 1



N° 2



N° 3



N° 5



N° 00



N° 0



N° 1



N° 2



N° 00



N° 0



N° 1



N° 2

1/2

VOLKMANN

32.470.00	17 cm 6 3/4"	N° 0	oval, mit Hohihaft
32.470.01	17 cm 6 3/4"	N° 1	oval, with hollow handle
32.470.02	17 cm 6 3/4"	N° 2	ovale, avec manche creux
32.470.03	17 cm 6 3/4"	N° 3	ovalada, con mango hueco
32.470.05	17 cm 6 3/4"	N° 5	ovale, con manico vuoto



N° 0010



N° 011



N° 112

1/2

WILLIGER

32.496.00	13,5 cm 5 1/4"	N° 0010
32.496.01	13,5 cm 5 1/4"	N° 011
32.496.12	13,5 cm 5 1/4"	N° 112



N° 0010



N° 011



N° 112

1/2

MARTINI

32.498.00	13,5 cm 5 1/4"	N° 0010
32.498.01	13,5 cm 5 1/4"	N° 011
32.498.12	13,5 cm 5 1/4"	N° 112



1/4

WILLIGER

82.820.20	16,5 cm 6 1/2"	N° 00
82.820.10	16,5 cm 6 1/2"	N° 0
82.821.01	16,5 cm 6 1/2"	N° 1
82.821.02	16,5 cm 6 1/2"	N° 2



1/4

WILLIGER

82.826.20	16,5 cm 6 1/2"	N° 00
82.826.10	16,5 cm 6 1/2"	N° 0
82.827.01	16,5 cm 6 1/2"	N° 1
82.827.02	16,5 cm 6 1/2"	N° 2



1/4

WILLIGER

82.822.20	16,5 cm 6 1/2"	N° 00
82.822.10	16,5 cm 6 1/2"	N° 0
82.823.01	16,5 cm 6 1/2"	N° 1
82.823.02	16,5 cm 6 1/2"	N° 2



1/4

WILLIGER

82.828.20	16,5 cm 6 1/2"	N° 00
82.828.10	16,5 cm 6 1/2"	N° 0
82.829.01	16,5 cm 6 1/2"	N° 1
82.829.02	16,5 cm 6 1/2"	N° 2



SCHARFE LÖFFEL
BONE CURETTES
CURETTES TRANCHANTES
CUCHARILLAS CORTANTES
CURETTE TAGLIENTI

SCHARFE LÖFFEL
BONE CURETTES
CURETTES TRANCHANTES
CUCHARILLAS CORTANTES
CURETTE TAGLIENTI

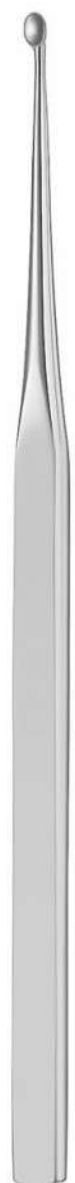
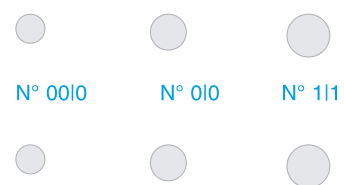

1/2

CHOMPRET

82.851.01 15 cml6"



1/2

WILLIGER

82.859.00	16 cml6 1/4"	N° 0010
82.859.10	16 cml6 1/4"	N° 010
82.859.11	16 cml6 1/4"	N° 111



1/2

MARTINI

82.863.00	16 cml6 1/4"	N° 0010
82.863.10	16 cml6 1/4"	N° 010
82.863.11	16 cml6 1/4"	N° 111



1/2

HEMINGWAY

82.871.11	18 cml7"	N° 1R1L
82.871.22	18 cml7"	N° 2R12L
82.871.33	18 cml7"	N° 3R13L



1/2

HEMINGWAY

82.871.11R	18 cml7"	N° 1R1L
82.871.22R	18 cml7"	N° 2R12L
82.871.33R	18 cml7"	N° 3R13L

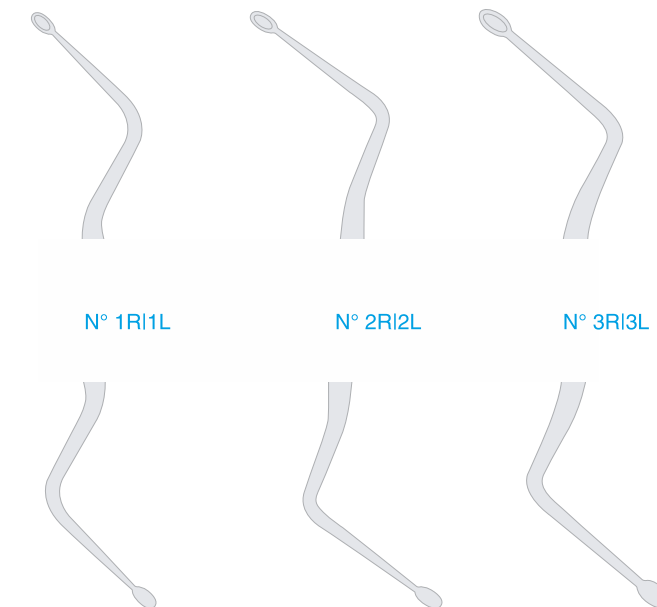

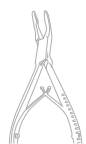

SCHARFE LÖFFEL
BONE CURETTES
CURETTES TRANCHANTES
CUCHARILLAS CORTANTES
CURETTE TAGLIENTI

KNOCHENFEILEN
BONE FILES
LIMES À OS
LIMAS PARA HUESOS
LIME PER OSSA



abwärts schneidend
downwards cutting
tranchant en bas
corte abajo
tagliente in basso

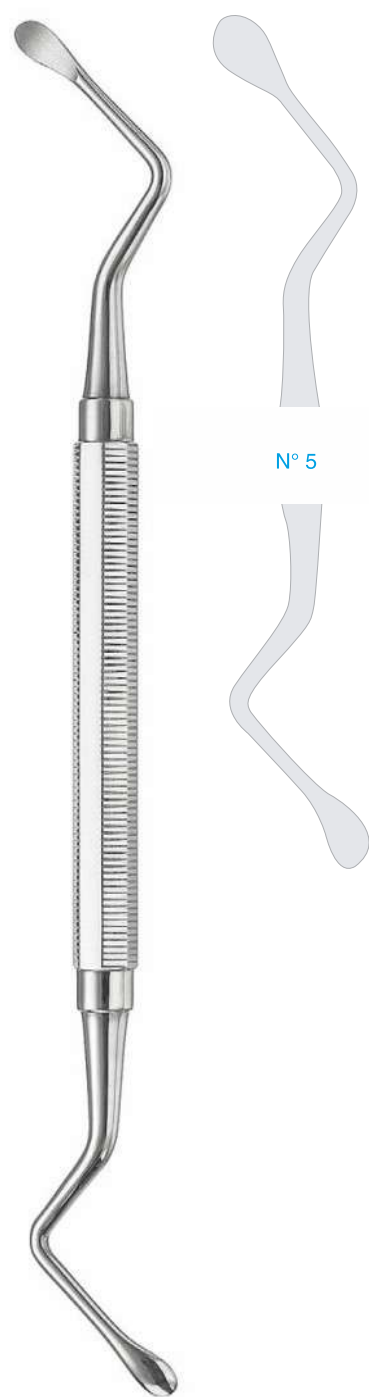
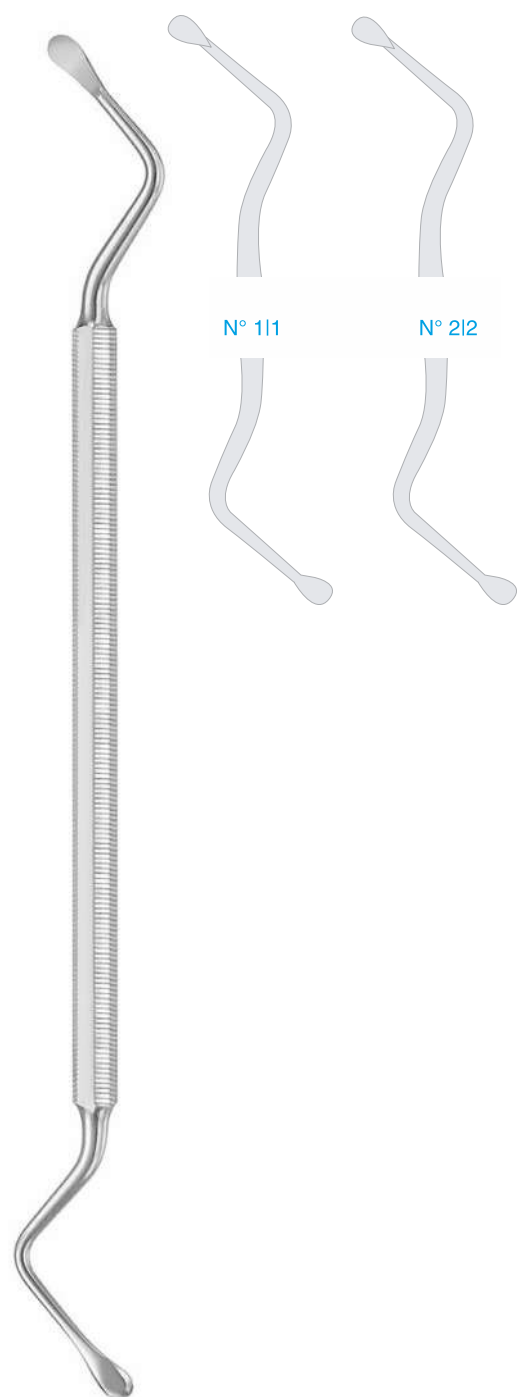

1/4
LUCAS
82.889.11 17 cml6 3/4" N° 111
82.889.22 17 cml6 3/4" N° 212

MEAD
82.890.05 17 cml6 3/4" N° 5

MOLT
82.909.01 16 cml6 1/4"

1/4
MILLER-COLBURN
82.895.01 18 cml7" N° 1

1/4
MILLER-COLBURN
82.895.02 18 cml7" N° 2

1/4
MILLER-COLBURN
82.895.03 18 cml7" N° 3



KNOCHENFEILEN
BONE FILES
LIMES À OS
LIMAS PARA HUESOS
LIME PER OSSA

ELEVATORIEN
ELEVATORS
ELÉVATEURS
ELEVADORES
ELEVATORI



abwärts schneidend
downwards cutting
tranchant en bas
corte abajo
tagliente in basso

Kreuzhieb
cross cut
coupe transversale
corte en cruz
tagliente a croce



1/4
MILLER-COLBURN
 82.895.04 18 cm 7" N° 4

1/4
MILLER-COLBURN
 82.895.05 18 cm 7" N° 5

1/4
MILLER-COLBURN
 82.896.01 18 cm 7" N° 1

1/4
SELDIN
 82.906.12 18 cm 7" N° 12

1/4
WILLIGER
 82.898.17 17 cm 6 3/4"

1/4
WILLIGER
 82.899.16 16 cm 6 1/4"

1/4
FREER
 46.415.18 18,5 cm 7 1/4"

1/4
FREER
 46.419.19 19 cm 7 1/2"

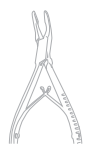

1/4
SELDIN
 82.905.22 19 cm 7 1/2" N° 22



1/4
SELDIN
 82.905.23 19 cm 7 1/2" N° 23



1/4
OHL
 82.902.18 18 cm 7"



1/4
GOLDMAN-FOX
 82.921.14 18 cm 7"



1/4
WILLIGER
 32.713.13 13 cm 5"



1/4
WILLIGER
 32.713.16 16 cm 6 1/4"



RASPATORIEN
PERIOSTEAL ELEVATORS
RUGINES RASPATOIRES, RUGINES
PERIOSTÓTOMOS, LEGRAS
PERIOSTOTOMI

FLACHMEISSEL
CHISELS
CISEAUX-BURINS
CINCELES
SCALPELLI



1/4

MOLT

82.909.24 19 cm 7 1/2" N° 214



1/4

MOLT

82.910.09 19 cm 7 1/2" N° 9



1/4

WAKEFILED

82.931.01 17 cm 6 3/4" N° 1W

4 mm



1/4

FREER

46.450.04 16 cm 6 1/4"

4 mm



1/4

FREER

46.451.04 16 cm 6 1/4"

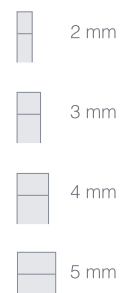

½

PARTSCH

32.620.02	13,5 cm 5¼"	2 mm
32.620.03	13,5 cm 5¼"	3 mm
32.620.04	13,5 cm 5¼"	4 mm
32.620.05	13,5 cm 5¼"	5 mm

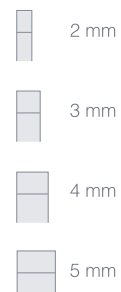

½

PARTSCH

32.622.02	17 cm 6¾"	2 mm
32.622.03	17 cm 6¾"	3 mm
32.622.04	17 cm 6¾"	4 mm
32.622.05	17 cm 6¾"	5 mm

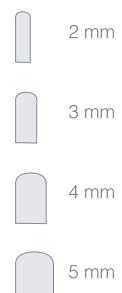

½

PARTSCH

32.623.02	13,5 cm 5¼"	2 mm
32.623.03	13,5 cm 5¼"	3 mm
32.623.04	13,5 cm 5¼"	4 mm
32.623.05	13,5 cm 5¼"	5 mm

09

- KNOPFSONDEN
- PROBES
- SONDES BOUTONNÉES
- SONDAS ABOTONADAS
- SONDE A BOTTONE

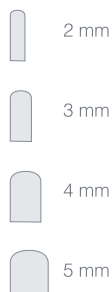

½

PARTSCH

32.625.02	17 cm 6¾"	2 mm
32.625.03	17 cm 6¾"	3 mm
32.625.04	17 cm 6¾"	4 mm
32.625.05	17 cm 6¾"	5 mm

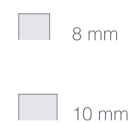

½

LEXER-MINI

32.664.08	18 cm 7"	8 mm
32.664.10	18 cm 7"	10 mm





½

20.104.11	11,5 cm 4½"	ø 1 mm
20.104.13	13 cm 5"	ø 1 mm
20.104.14	14,5 cm 5¾"	ø 1 mm

N°	00	0	1	2	3	4	5	6	7	8
ø mm	0,7	0,8	0,9	1,1	1,3	1,4	1,5	1,6	1,8	1,9



½

BOWMAN

42.616.00	13 cm 5"	N° 0010	Neusilber
42.616.01	13 cm 5"	N° 011	nickel silver
42.616.12	13 cm 5"	N° 112	maillechort
42.616.23	13 cm 5"	N° 213	alpaca
42.616.34	13 cm 5"	N° 314	argentone
42.616.45	13 cm 5"	N° 415	
42.616.56	13 cm 5"	N° 516	
42.616.67	13 cm 5"	N° 617	
42.616.78	13 cm 5"	N° 718	



½

BOWMAN

42.614.00	13 cm 5"	N° 0010	Neusilber
42.614.01	13 cm 5"	N° 011	nickel silver
42.614.12	13 cm 5"	N° 112	maillechort
42.614.23	13 cm 5"	N° 213	alpaca
42.614.34	13 cm 5"	N° 314	argentone
42.614.45	13 cm 5"	N° 415	
42.614.56	13 cm 5"	N° 516	
42.614.67	13 cm 5"	N° 617	
42.614.78	13 cm 5"	N° 718	

10

- MUND UND ZUNGE
 MOUTH AND TONGUE
 BOUCHE ET LANGUE
 BOCA Y LENGUA
 BOCCA E LINGUA





ZUNGENSPATEL
 TONGUE DEPRESSORS
 ABAISSE-LANGUE
 ABAJALENGUA
 ABBASSALINGUA

ZUNGENSPATEL
 TONGUE DEPRESSORS
 ABAISSE-LANGUE
 ABAJALENGUA
 ABBASSALINGUA



Holz, Packung 100 Stück
 wood, package 100 pieces
 bois, boîte 100 pièces
 madera, paquete 100 piezas
 legno, confezione 100 pezzi

½
 48.102.16 16 cm 6¼"



½
FRENZEL
 48.105.16 16,5 cm 6½"



½
BRUENINGS
 48.107.19 19 cm 7½"



½
TOBOLD
 48.119.14 14,5 cm 5¾"



½
TOBOLD
 48.119.15 15 cm 6"



½
BUCHWALD
 48.109.19 19 cm 7½"



½
HARTMANN
 48.111.15 15 cm 6"



½
WIEDER
 48.115.01 14 cm 5½" 36 mm
 48.115.02 15 cm 6" 43 mm



½
DOYEN
 48.112.13 13,5 cm 5¼"
 48.112.16 16 cm 6¼"



24 | 30 mm

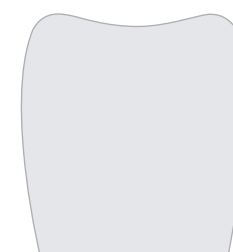

30 | 34 mm





$\frac{1}{2}$
STERNBERG
 48.229.14 14 cm 5½"



$\frac{1}{2}$
SIMPLEX
 48.230.11 11 cm 4¼"



$\frac{1}{2}$
DOYEN-JANSEN (MOLT)
 48.265.12 12 cm 4¾"
 48.265.14 14 cm 5½"



$\frac{1}{2}$
DENHARDT
 48.267.12 12 cm 4¾"



$\frac{1}{2}$
ROSER-KOENIG
 48.270.16 16 cm 6¼"
 48.270.19 19 cm 7½"



$\frac{1}{2}$
CAWOOD-MINNESOTA
 48.233.15 15 cm 6"



$\frac{1}{2}$
CAWOOD-MINNESOTA
 48.233.14KL 14 cm 5½"



$\frac{1}{2}$
HEISTER
 48.272.13 13 cm 5"



$\frac{1}{2}$
JENNINGS
 48.274.09 9 cm 3½"
 48.274.11 11 cm 4¼"
 48.274.13 13 cm 5"
 48.274.15 15 cm 6"



½

DINGMANN

48.330.00 14,5 cm | 5¾"

komplett mit Rahmen, 3 Zungendrucker, 2 Seitenvalven und 2 Zahnplatten
complete with frame, 3 tongue depressors, 2 lateral blades and 2 tooth plates
complet avec cadre, 3 abaisse-langue, 2 valves latérales et 2 plaques dentaires
completo con bastidor, 3 abajalengua, 2 valvas laterales y 2 placas dentales
completo con telaio, 3 abassalingua, 2 valve laterali e 2 placche per denti

48.330.09 14,5 cm | 5¾"

nur Rahmen
only frame
seulement cadre
sólo bastidor
solo telaio



½

48.330.01 13,5 cm | 5¼" 65 x 25 mm



½

48.330.02 13,5 cm | 5¼" 70 x 29 mm



½

48.330.03 13,5 cm | 5¼" 80 x 32 mm

Zungendrucker, gefenestertes Blatt für Absaugung
tongue depressor, fenestrated blade for suction
abaisse-langue, lame fenêtrée pour aspiration
abajalengua, hoja fenestrada para succión
abassalingua, lama con finestra per aspirazione



Bruststütze
chest support
support de poitrine
soporte de pecho
supporto per petto

½

KILNER-DOUGHTY

48.314.00 Höhe verstellbar
adjustable height
hauteur réglable
altura ajustable
altezza regolabile



½

COLLIN

48.250.16 16 cm | 6¼"
48.250.18 18 cm | 7"



½

YOUNG

48.255.16 16 cm | 6¼"
48.255.99 Gummipolster (Paar)
rubber inserts (pair)
rembourrage en caoutchouc (paire)
bocas de goma (par)
cuscinio di gomma (paio)

Zungenzangen
tongue holding forceps
pinces tire-langues
pinzas tira-lengua
pinze per lingua

Fingerschutz
finger protector
doigtiers
dedal
ditale



LANGENBECK

48.371.01 ø 17 - 21 mm

Serviettenhalter
napkin holder
porte-serviette
servilletero
portatovaglioli



ADAMS

48.367.00

Tamponstopfer
gauze packer
porte-tampon
taponeador
tamponatori



LUNIATSCHEK

50.151.19 19 cm | 7½"

11

- ZAHNZANGEN
EXTRACTING FORCEPS
DAVIERS
PINZAS DE EXTRACCIÓN
PINZE PER ESTRAZIONE

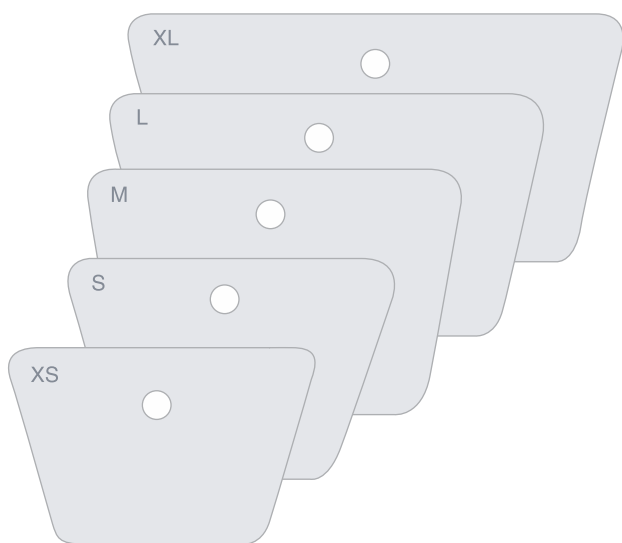

XL extra groß, für Zahnlose
extra large, for edentulous
très grand, pour édentées
muy grande, para desdentados
molto grande, per sdentati

L groß, für Erwachsene
large, for adults
grand, pour adultes
grande, para adultos
grande, per adulti

M normal, für Erwachsene
regular, for adults
régulier, pour adultes
regular, para adultos
regolare, per adulti

S klein, für Kinder
small, for children
petit, pour enfants
pequeño, para niños
piccolo, per bambini

XS klein, für Kleinkinder
small, for babies
petit, pour bébés
pequeño, para bebés
piccolo, per neonati



MCKESSON

48.362.58	XS	kunststoffbeschichteter Metallrahmen ohne Kette
48.362.56	S	plastic coated metal frame without chain
48.362.54	M	cadre métallique avec revêtement synthétique sans chaîne
48.362.52	L	cuadro metálico, cubierto de plástico sin cadena
48.362.50	XL	telaio metallico, ricoperto in plastica senza catena

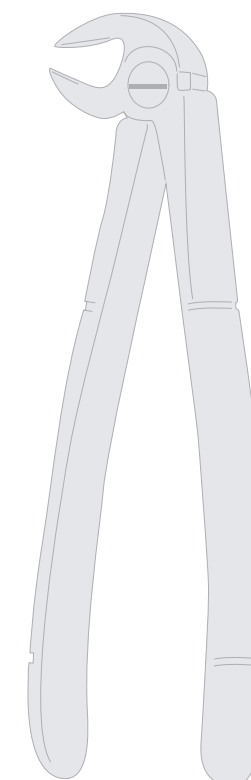



ZAHNZANGEN, ENGLISCHE FORM
 EXTRACTING FORCEPS, ENGLISH PATTERN
 DAVIERS, FORME ANGLAISE
 PINZAS DE EXTRACCIÓN, FORMA INGLESA
 PINZE PER ESTRAZIONE, FORMA INGLESE

ZAHNZANGEN, ENGLISCHE FORM
 EXTRACTING FORCEPS, ENGLISH PATTERN
 DAVIERS, FORME ANGLAISE
 PINZAS DE EXTRACCIÓN, FORMA INGLESA
 PINZE PER ESTRAZIONE, FORMA INGLESE

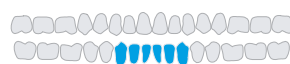
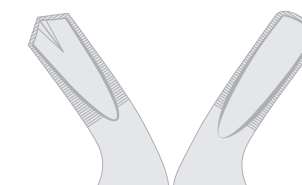
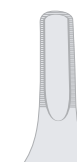
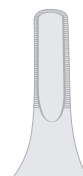
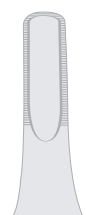

80.001.00 N° 1

80.002.00 N° 2

80.004.00 N° 4

80.007.00 N° 7

80.013.00 N° 13

80.017.00 N° 17



ZAHNZANGEN, ENGLISCHE FORM
 EXTRACTING FORCEPS, ENGLISH PATTERN
 DAVIERS, FORME ANGLAISE
 PINZAS DE EXTRACCIÓN, FORMA INGLESA
 PINZE PER ESTRAZIONE, FORMA INGLESE

ZAHNZANGEN, ENGLISCHE FORM
 EXTRACTING FORCEPS, ENGLISH PATTERN
 DAVIERS, FORME ANGLAISE
 PINZAS DE EXTRACCIÓN, FORMA INGLESA
 PINZE PER ESTRAZIONE, FORMA INGLESE

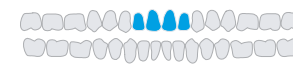
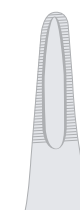
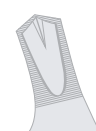
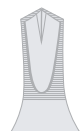
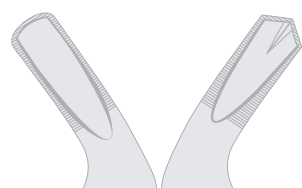

80.018.00 N° 18

80.018.01 N° 18A

80.022.00 N° 22

80.023.00 N° 23

80.024.00 N° 24

80.029.00 N° 29



ZAHNZANGEN, ENGLISCHE FORM
 EXTRACTING FORCEPS, ENGLISH PATTERN
 DAVIERS, FORME ANGLAISE
 PINZAS DE EXTRACCIÓN, FORMA INGLESA
 PINZE PER ESTRAZIONE, FORMA INGLESE

ZAHNZANGEN, ENGLISCHE FORM
 EXTRACTING FORCEPS, ENGLISH PATTERN
 DAVIERS, FORME ANGLAISE
 PINZAS DE EXTRACCIÓN, FORMA INGLESA
 PINZE PER ESTRAZIONE, FORMA INGLESE



tiefgreifend
 deep-gripping
 profond
 profundo

tiefgreifend
 deep-gripping
 profond
 profundo

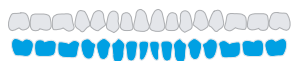
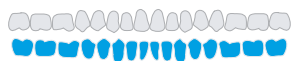
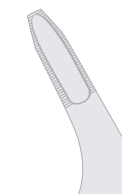
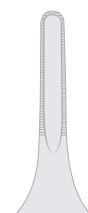
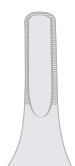
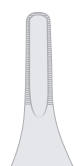
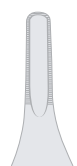

80.033.00 N° 33

80.033.01 N° 33A

80.033.03 N° 33C

80.033.06 N° 33M

80.034.00 N° 34

80.035.00 N° 35



ZAHNZANGEN, ENGLISCHE FORM
 EXTRACTING FORCEPS, ENGLISH PATTERN
 DAVIERS, FORME ANGLAISE
 PINZAS DE EXTRACCIÓN, FORMA INGLESA
 PINZE PER ESTRAZIONE, FORMA INGLESE

tiefgreifend
 deep-gripping
 profond
 profundo

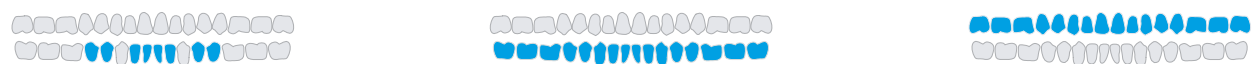
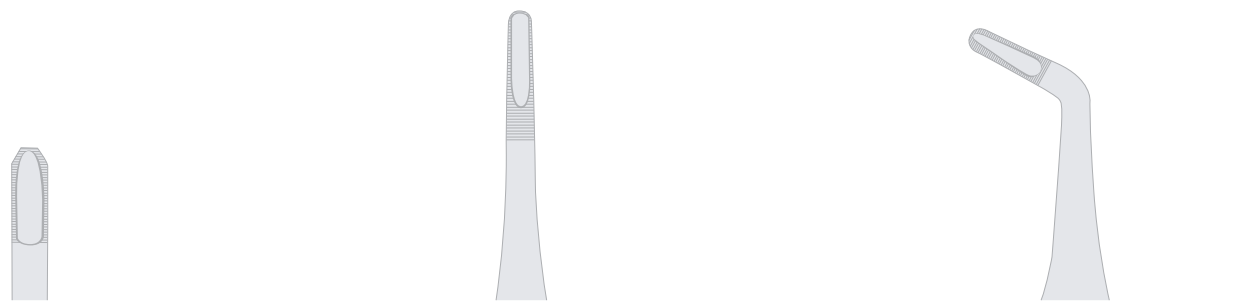

80.036.02 N° 36

80.041.00 N° 41

80.045.00 N° 45

tiefgreifend
 deep-gripping
 profond
 profundo

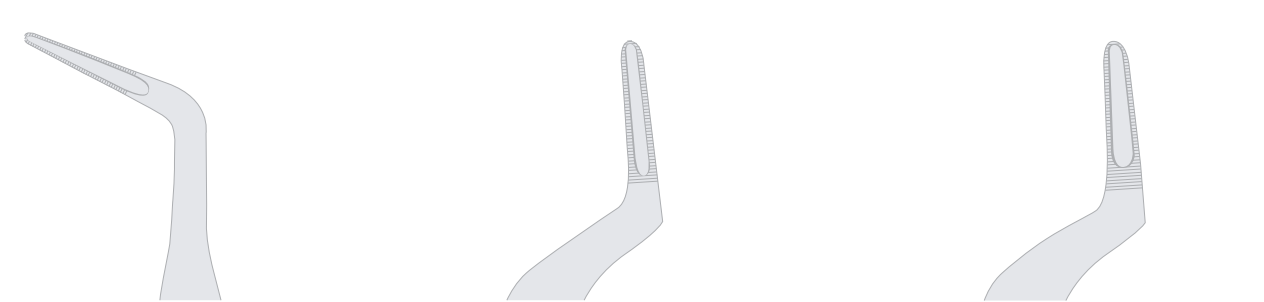

80.046.12 N° 46L

80.051.00 N° 51

80.051.01 N° 51A

ZAHNZANGEN, ENGLISCHE FORM
 EXTRACTING FORCEPS, ENGLISH PATTERN
 DAVIERS, FORME ANGLAISE
 PINZAS DE EXTRACCIÓN, FORMA INGLESA
 PINZE PER ESTRAZIONE, FORMA INGLESE





ZAHNZANGEN, ENGLISCHE FORM
 EXTRACTING FORCEPS, ENGLISH PATTERN
 DAVIERS, FORME ANGLAISE
 PINZAS DE EXTRACCIÓN, FORMA INGLESA
 PINZE PER ESTRAZIONE, FORMA INGLESE

ZAHNZANGEN, ENGLISCHE FORM
 EXTRACTING FORCEPS, ENGLISH PATTERN
 DAVIERS, FORME ANGLAISE
 PINZAS DE EXTRACCIÓN, FORMA INGLESA
 PINZE PER ESTRAZIONE, FORMA INGLESE

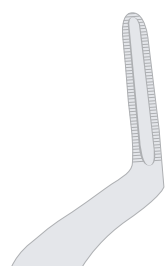

80.051.03 N° 51C

80.053.00 N° 53

80.055.00 N° 55

80.067.00 N° 67

80.073.00 N° 73

80.074.00 N° 74



ZAHNZANGEN, ENGLISCHE FORM
 EXTRACTING FORCEPS, ENGLISH PATTERN
 DAVIERS, FORME ANGLAISE
 PINZAS DE EXTRACCIÓN, FORMA INGLESA
 PINZE PER ESTRAZIONE, FORMA INGLESE

ZAHNZANGEN, ENGLISCHE FORM
 EXTRACTING FORCEPS, ENGLISH PATTERN
 DAVIERS, FORME ANGLAISE
 PINZAS DE EXTRACCIÓN, FORMA INGLESA
 PINZE PER ESTRAZIONE, FORMA INGLESE



für abgebrochenen Kronen
 for broken crowns
 pour couronnes cassées
 para coronas dañadas
 per corone spezzate

für abgebrochenen Kronen
 for broken crowns
 pour couronnes cassées
 para coronas dañadas
 per corone spezzate



80.075.00 N° 75



80.076.00 N° 76



80.079.00 N° 79



80.086.01 N° 86A



80.087.00 N° 87



80.089.00 N° 89



ZAHNZANGEN, ENGLISCHE FORM
 EXTRACTING FORCEPS, ENGLISH PATTERN
 DAVIERS, FORME ANGLAISE
 PINZAS DE EXTRACCIÓN, FORMA INGLESA
 PINZE PER ESTRAZIONE, FORMA INGLESE

ZAHNZANGEN, ENGLISCHE FORM
 EXTRACTING FORCEPS, ENGLISH PATTERN
 DAVIERS, FORME ANGLAISE
 PINZAS DE EXTRACCIÓN, FORMA INGLESA
 PINZE PER ESTRAZIONE, FORMA INGLESE

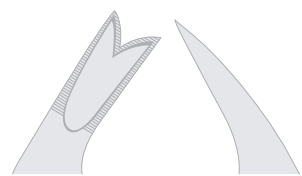

80.090.00 N° 90

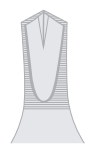

WOOD
 80.099.00 N° 99

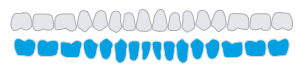

80.333.09 N° 333S

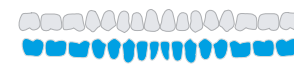
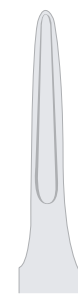

80.233.00 N° 233



80.235.00 N° 235

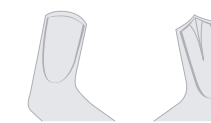

KÖHLERT-WHITE
 80.198.00 N° 198



ZAHNZANGEN, ENGLISCHE FORM
 EXTRACTING FORCEPS, ENGLISH PATTERN
 DAVIERS, FORME ANGLAISE
 PINZAS DE EXTRACCIÓN, FORMA INGLESA
 PINZE PER ESTRAZIONE, FORMA INGLESE

WURZELSPLITTERZANGEN
 ROOT SPLITTER FORCEPS
 DAVIERS À FRAGMENTS POUR RACINES DENTAIRE
 PINZAS PARA FRAGMENTOS DE RACICES
 PINZE PER FRAGMENTI DE RADICI

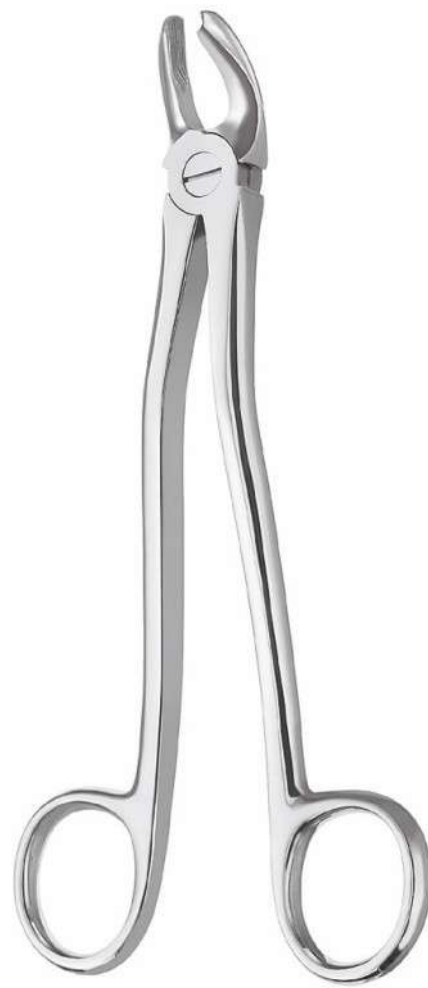
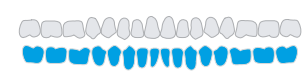
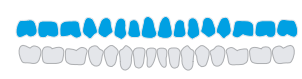
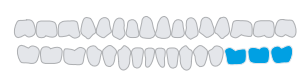
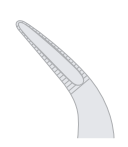
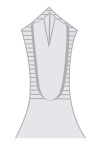
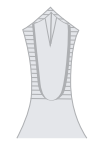
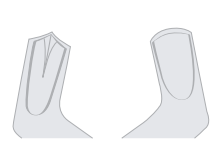

KÖHLERT-WHITE
 80.199.00 N° 199

ROUTURIER
 80.422.05

ROUTURIER
 80.422.08

81.300.00 N° 300

81.301.00 N° 301



ZAHNZANGEN, AMERIKANISCHE FORM
 EXTRACTING FORCEPS, AMERICAN PATTERN
 DAVIERS, FORME AMÉRICAINNE
 PINZAS DE EXTRACCIÓN, FORMA AMERICANA
 PINZE PER ESTRAZIONE, FORMA AMERICANA

ZAHNZANGEN, AMERIKANISCHE FORM
 EXTRACTING FORCEPS, AMERICAN PATTERN
 DAVIERS, FORME AMÉRICAINNE
 PINZAS DE EXTRACCIÓN, FORMA AMERICANA
 PINZE PER ESTRAZIONE, FORMA AMERICANA

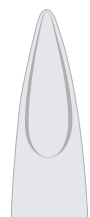
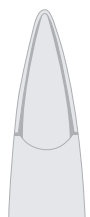

81.001.00 N° 1

HENAHAN
 81.001.01 N° 1A

81.001.02 N° 1B

MILWAUKEE
 81.003.00 N° 3

WOOD-WARD
 81.003.04 N° 3FH

WOOD-WARD
 81.003.09 N° 3FS



ZAHNZANGEN, AMERIKANISCHE FORM
 EXTRACTING FORCEPS, AMERICAN PATTERN
 DAVIERS, FORME AMÉRICAINNE
 PINZAS DE EXTRACCIÓN, FORMA AMERICANA
 PINZE PER ESTRAZIONE, FORMA AMERICANA

ZAHNZANGEN, AMERIKANISCHE FORM
 EXTRACTING FORCEPS, AMERICAN PATTERN
 DAVIERS, FORME AMÉRICAINNE
 PINZAS DE EXTRACCIÓN, FORMA AMERICANA
 PINZE PER ESTRAZIONE, FORMA AMERICANA

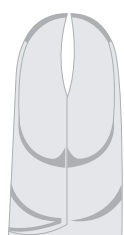
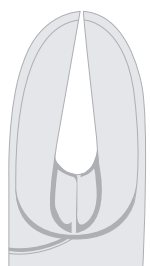

Spaltzange
 splitting forceps
 daviers pour séparer les racines
 pinzas para separar raíces
 tenaglie per scindere le radici

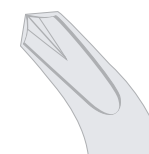
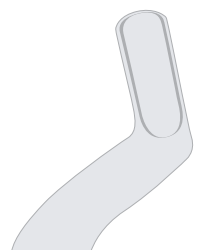

PHYSICK

81.005.00 N° 5

81.006.00 N° 6

81.010.04 N° 10H

81.010.09 N° 10S

HARRIS

81.015.00 N° 15

HARRIS

81.016.00 N° 16



ZAHNZANGEN, AMERIKANISCHE FORM
 EXTRACTING FORCEPS, AMERICAN PATTERN
 DAVIERS, FORME AMÉRICAINNE
 PINZAS DE EXTRACCIÓN, FORMA AMERICANA
 PINZE PER ESTRAZIONE, FORMA AMERICANA

ZAHNZANGEN, AMERIKANISCHE FORM
 EXTRACTING FORCEPS, AMERICAN PATTERN
 DAVIERS, FORME AMÉRICAINNE
 PINZAS DE EXTRACCIÓN, FORMA AMERICANA
 PINZE PER ESTRAZIONE, FORMA AMERICANA



81.016.09 N° 16S

81.017.00 N° 17

HARRIS
 81.018.05 N° 18L

HARRIS
 81.018.08 N° 18R

81.023.00 N° 23

HARRIS
 81.024.00 N° 24



ZAHNZANGEN, AMERIKANISCHE FORM
 EXTRACTING FORCEPS, AMERICAN PATTERN
 DAVIERS, FORME AMÉRICAINNE
 PINZAS DE EXTRACCIÓN, FORMA AMERICANA
 PINZE PER ESTRAZIONE, FORMA AMERICANA

ZAHNZANGEN, AMERIKANISCHE FORM
 EXTRACTING FORCEPS, AMERICAN PATTERN
 DAVIERS, FORME AMÉRICAINNE
 PINZAS DE EXTRACCIÓN, FORMA AMERICANA
 PINZE PER ESTRAZIONE, FORMA AMERICANA

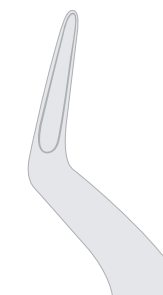
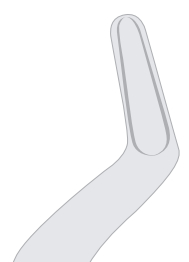

81.032.00 N° 32

81.032.01 N° 32A

81.053.05 N° 53L

81.053.08 N° 53R

81.062.00 N° 62

81.065.00 N° 65



ZAHNZANGEN, AMERIKANISCHE FORM
 EXTRACTING FORCEPS, AMERICAN PATTERN
 DAVIERS, FORME AMÉRICAINNE
 PINZAS DE EXTRACCIÓN, FORMA AMERICANA
 PINZE PER ESTRAZIONE, FORMA AMERICANA

Wurzelsplitter und kleine Wurzeln
 root fragments and small roots
 fragments de racines et racines fines
 fragmentos de raíces y raíces muy delgadas
 frammenti di radici e radici piccole

ZAHNZANGEN, AMERIKANISCHE FORM
 EXTRACTING FORCEPS, AMERICAN PATTERN
 DAVIERS, FORME AMÉRICAINNE
 PINZAS DE EXTRACCIÓN, FORMA AMERICANA
 PINZE PER ESTRAZIONE, FORMA AMERICANA



81.069.00 N° 69



THOMAS
 81.085.00 N° 85



THOMAS
 81.085.01 N° 85A



NEVIUS
 81.088.05 N° 88L



NEVIUS
 81.088.08 N° 88R



KELLS
 81.099.01 N° 99A



ZAHNZANGEN, AMERIKANISCHE FORM
 EXTRACTING FORCEPS, AMERICAN PATTERN
 DAVIERS, FORME AMÉRICAINNE
 PINZAS DE EXTRACCIÓN, FORMA AMERICANA
 PINZE PER ESTRAZIONE, FORMA AMERICANA

ZAHNZANGEN, AMERIKANISCHE FORM
 EXTRACTING FORCEPS, AMERICAN PATTERN
 DAVIERS, FORME AMÉRICAINNE
 PINZAS DE EXTRACCIÓN, FORMA AMERICANA
 PINZE PER ESTRAZIONE, FORMA AMERICANA

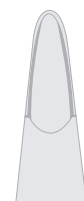
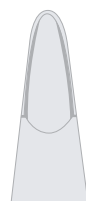
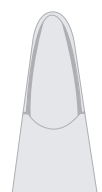

KELLS

81.099.03 N° 99C

HULL

81.101.00 N° 101

81.110.04 N° 10H

81.110.09 N° 10S

CRYER

81.150.00 N° 150

CRYER

81.150.01 N° 150A



ZAHNZANGEN, AMERIKANISCHE FORM
 EXTRACTING FORCEPS, AMERICAN PATTERN
 DAVIERS, FORME AMÉRICAINNE
 PINZAS DE EXTRACCIÓN, FORMA AMERICANA
 PINZE PER ESTRAZIONE, FORMA AMERICANA

ZAHNZANGEN, AMERIKANISCHE FORM
 EXTRACTING FORCEPS, AMERICAN PATTERN
 DAVIERS, FORME AMÉRICAINNE
 PINZAS DE EXTRACCIÓN, FORMA AMERICANA
 PINZE PER ESTRAZIONE, FORMA AMERICANA



CRYER
 81.150.02 N° 150X

CRYER
 81.150.03 N° 150AB

CRYER
 81.151.00 N° 151

CRYER
 81.151.01 N° 151A

CRYER
 81.151.02 N° 151X

CRYER
 81.151.03 N° 151AB



ZAHNZANGEN, AMERIKANISCHE FORM
 EXTRACTING FORCEPS, AMERICAN PATTERN
 DAVIERS, FORME AMÉRICAINNE
 PINZAS DE EXTRACCIÓN, FORMA AMERICANA
 PINZE PER ESTRAZIONE, FORMA AMERICANA

ZAHNZANGEN, AMERIKANISCHE FORM
 EXTRACTING FORCEPS, AMERICAN PATTERN
 DAVIERS, FORME AMÉRICAINNE
 PINZAS DE EXTRACCIÓN, FORMA AMERICANA
 PINZE PER ESTRAZIONE, FORMA AMERICANA

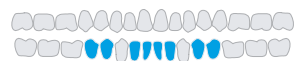

CRYER
 81.151.08 N° 151AS



81.201.00 N° 201



81.203.00 N° 203



81.210.04 N° 210H



81.210.09 N° 210S

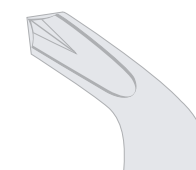

81.217.00 N° 217



ZAHNZANGEN, AMERIKANISCHE FORM
 EXTRACTING FORCEPS, AMERICAN PATTERN
 DAVIERS, FORME AMÉRICAINNE
 PINZAS DE EXTRACCIÓN, FORMA AMERICANA
 PINZE PER ESTRAZIONE, FORMA AMERICANA

ZAHNZANGEN, AMERIKANISCHE FORM
 EXTRACTING FORCEPS, AMERICAN PATTERN
 DAVIERS, FORME AMÉRICAINNE
 PINZAS DE EXTRACCIÓN, FORMA AMERICANA
 PINZE PER ESTRAZIONE, FORMA AMERICANA

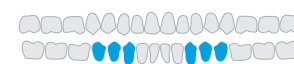
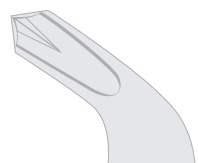
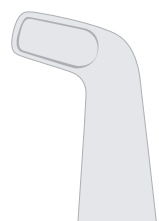

81.222.00 N° 222

81.286.00 N° 286

81.287.00 N° 287

81.288.00 N° 288

► Wenn Sie Interesse an Zahnzangen Haftprofil haben, kontaktieren Sie uns gerne.
 In case you are interested in non-slip extracting forceps, please do not hesitate to contact us.
 Si vous vous intéressez aux daviers rententiifs, n'hésitez pas à nous contacter.
 En caso de que se interesen por forceps con perfil ret, no tardarian en contactarnos.
 Se avete interesse a pinze dentali profilo adesione, non esitate a contattarci.



WURZELSCHRAUBEN
 ROOT SCREWS
 VIS À RACINES
 TORNILLOS PARA RAÍCES
 VITI PER RADICI

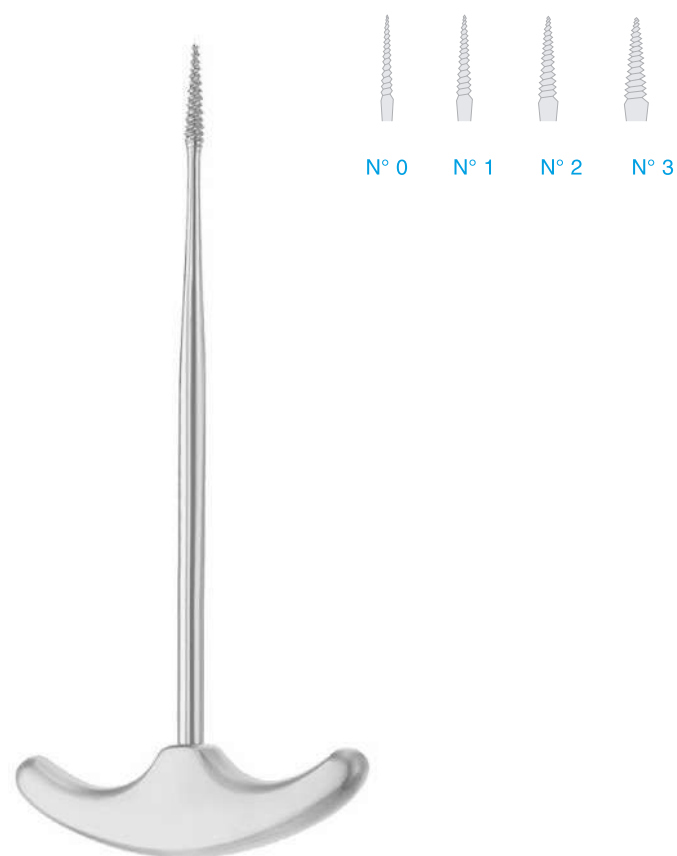

N° 0 N° 1 N° 2 N° 3

MORRISON

81.820.00	N° 0
81.820.01	N° 1
81.820.02	N° 2
81.820.03	N° 3

12

- KINDERZAHNZANGEN
 EXTRACTING FORCEPS FOR CHILDREN
 DAVIERS POUR ENFANTS
 PINZAS DE EXTRACCIÓN PARA NIÑOS
 PINZE PER ESTRAZIONE PER BAMBINI

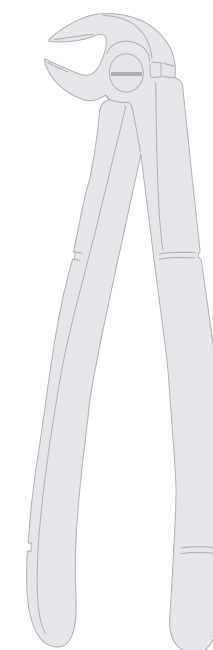



KINDERZAHNZANGEN, ENGLISCHE FORM
 EXTRACTING FORCEPS FOR CHILDREN, ENGLISH PATTERN
 DAVIERS POUR ENFANTS, FORME ANGLAISE
 FÓRCEPS DENTALES PARA NIÑOS, FORMA INGLESA
 PINZE PER ESTRAZIONE PER BAMBINI, FORMA INGLESE

KINDERZAHNZANGEN, ENGLISCHE FORM
 EXTRACTING FORCEPS FOR CHILDREN, ENGLISH PATTERN
 DAVIERS POUR ENFANTS, FORME ANGLAISE
 FÓRCEPS DENTALES PARA NIÑOS, FORMA INGLESA
 PINZE PER ESTRAZIONE PER BAMBINI, FORMA INGLESE



KLEIN
 80.703.00 N° 3

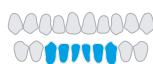

KLEIN
 80.705.00 N° 5



KLEIN
 80.706.00 N° 6



KLEIN
 80.707.00 N° 7



80.613.09 N° 13S



80.622.09 N° 22S



KINDERZAHNZANGEN, ENGLISCHE FORM
 EXTRACTING FORCEPS FOR CHILDREN, ENGLISH PATTERN
 DAVIERS POUR ENFANTS, FORME ANGLAISE
 FÓRCEPS DENTALES PARA NIÑOS, FORMA INGLESA
 PINZE PER ESTRAZIONE PER BAMBINI, FORMA INGLESE

KINDERZAHNZANGEN, ENGLISCHE FORM
 EXTRACTING FORCEPS FOR CHILDREN, ENGLISH PATTERN
 DAVIERS POUR ENFANTS, FORME ANGLAISE
 FÓRCEPS DENTALES PARA NIÑOS, FORMA INGLESA
 PINZE PER ESTRAZIONE PER BAMBINI, FORMA INGLESE



80.629.09 N° 29S

80.630.09 N° 30S

80.633.09 N° 33S

80.637.00 N° 37

80.638.00 N° 38

80.639.00 N° 39



KINDERZAHNZANGEN, ENGLISCHE FORM
 EXTRACTING FORCEPS FOR CHILDREN, ENGLISH PATTERN
 DAVIERS POUR ENFANTS, FORME ANGLAISE
 FÓRCEPS DENTALES PARA NIÑOS, FORMA INGLESA
 PINZE PER ESTRAZIONE PER BAMBINI, FORMA INGLESE

KINDERZAHNZANGEN, ENGLISCHE FORM
 EXTRACTING FORCEPS FOR CHILDREN, ENGLISH PATTERN
 DAVIERS POUR ENFANTS, FORME ANGLAISE
 FÓRCEPS DENTALES PARA NIÑOS, FORMA INGLESA
 PINZE PER ESTRAZIONE PER BAMBINI, FORMA INGLESE

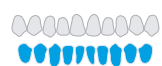
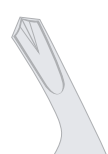

80.639.01 N° 39A



80.639.05 N° 39L



80.639.08 N° 39R



80.640.00 N° 40



80.651.09 N° 51S



KLEIN
 80.751.09 N° 51S



KINDERZAHNZANGEN, ENGLISCHE FORM
 EXTRACTING FORCEPS FOR CHILDREN, ENGLISH PATTERN
 DAVIERS POUR ENFANTS, FORME ANGLAISE
 FÓRCEPS DENTALES PARA NIÑOS, FORMA INGLESA
 PINZE PER ESTRAZIONE PER BAMBINI, FORMA INGLESE

KINDERZAHNZANGEN, AMERIKANISCHE FORM
 EXTRACTING FORCEPS FOR CHILDREN, AMERICAN PATTERN
 DAVIERS POUR ENFANTS, FORME AMÉRICAINNE
 FÓRCEPS DENTALES PARA NIÑOS, FORMA AMERICANA
 PINZE PER ESTRAZIONE PER BAMBINI, FORMA AMERICANA

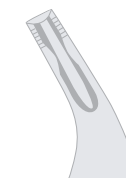
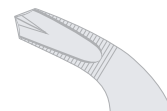

LAWRENCE-READ

80.676.09 N° 76S

KLEIN

80.737.00 N° 137

KLEIN

80.739.00 N° 139

80.817.09 N° 17SK

80.823.09 N° 23SK

81.150.08 N° 150AS



KINDERZAHNZANGEN, AMERIKANISCHE FORM
 EXTRACTING FORCEPS FOR CHILDREN, AMERICAN PATTERN
 DAVIERS POUR ENFANTS, FORME AMÉRICAINNE
 FÓRCEPS DENTALES PARA NIÑOS, FORMA AMERICANA
 PINZE PER ESTRAZIONE PER BAMBINI, FORMA AMERICANA

KINDERZAHNZANGEN, AMERIKANISCHE FORM
 EXTRACTING FORCEPS FOR CHILDREN, AMERICAN PATTERN
 DAVIERS POUR ENFANTS, FORME AMÉRICAINNE
 FÓRCEPS DENTALES PARA NIÑOS, FORMA AMERICANA
 PINZE PER ESTRAZIONE PER BAMBINI, FORMA AMERICANA

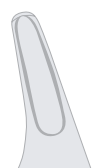

CRYER
 81.150.09 N° 150S

80.850.09 N° 150SK

CRYER
 81.151.09 N° 151 S

80.851.09 N° 151SK



MILCHZAHNPINZETTEN
 FORCEPS FOR DECIDUOUS TEETH
 PINCES À DENTS DE LAIT
 PINZAS PARA DIENTES DE LECHE
 PINZE PER DENTI DI LATTE

13

- WURZELHEBER
 ROOT ELEVATORS
 ELÉVATEURS DE RACINES
 ELEVADORES PARA RAÍCES
 LEVE PER RADICI



1/2

ALBRECHT

81.811.16 16 cm 6 1/4"



1/2

ALBRECHT

81.812.16 16 cm 6 1/4"

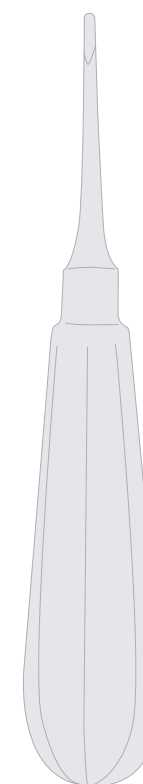

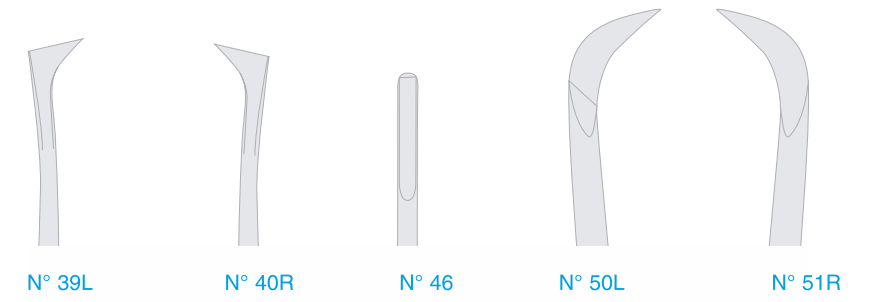
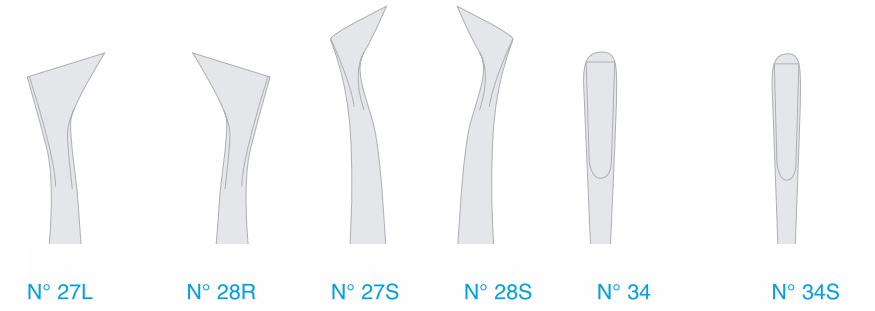
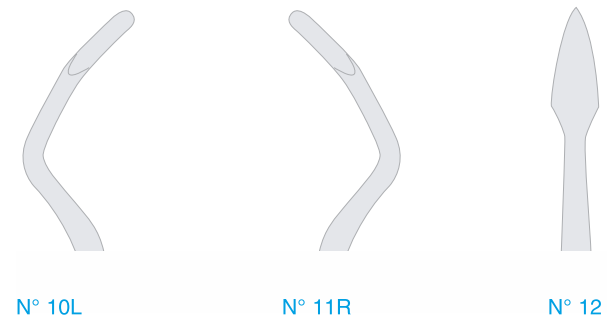
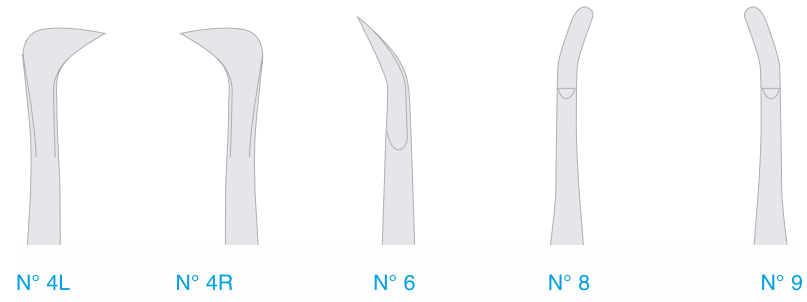
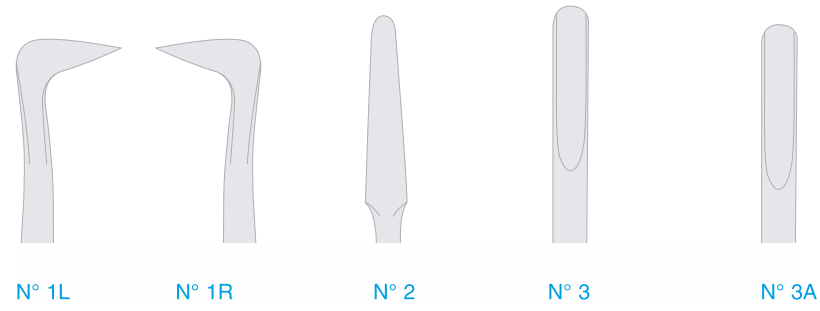

1/4

1/4

82.001.05	N° 1L	SELDIN
82.001.08	N° 1R	SELDIN
82.002.00	N° 2	SELDIN
82.003.00	N° 3	SELDIN
82.003.01	N° 3A	CRYER
82.004.05	N° 4L	SELDIN
82.004.08	N° 4R	SELDIN
82.006.00	N° 6	CRANE-COGSWELL
82.008.00	N° 8	MILLER
82.009.00	N° 9	MILLER
82.010.00	N° 10L	MILLER-APEXO
82.011.00	N° 11R	MILLER-APEXO
82.012.00	N° 12	CRYER

82.027.00	N° 27L	CRYER
82.028.00	N° 28R	CRYER
82.027.01	N° 27S	CRYER
82.028.01	N° 28S	CRYER
82.034.00	N° 34	SELDIN
82.034.09	N° 34S	SELDIN
82.039.00	N° 39L	CRYER
82.040.00	N° 40R	CRYER
82.046.00	N° 46	FLOHR
82.050.00	N° 50L	W.F-BARRY
82.051.00	N° 51R	W.F-BARRY



WURZELHEBER
 ROOT ELEVATORS
 ELÉVATEURS DE RACINES
 ELEVADORES PARA RAÍCES
 LEVE PER RADICI

WURZELHEBER
 ROOT ELEVATORS
 ELÉVATEURS DE RACINES
 ELEVADORES PARA RAÍCES
 LEVE PER RADICI

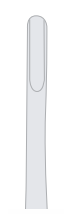

N° 301



N° 1



N° 1

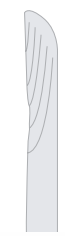

N° 1



N° 2

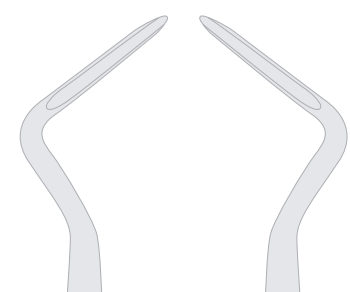

N° 302

N° 303

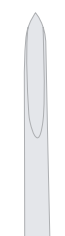

N° 304

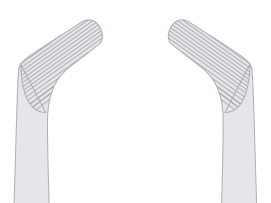

N° 2L

N° 3R

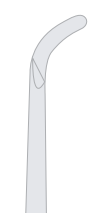

N° 2L

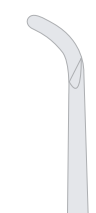

N° 3R



N° 3



N° 4

1/4

1/4

1/4

1/4

- 82.301.00 N° 301 APICAL
- 82.302.00 N° 302 APICAL-FLOHR
- 82.303.00 N° 303 APICAL-FLOHR
- 82.304.00 N° 304 APICAL

COLEMANN

- 82.405.01 N° 1
- 82.405.02 N° 2L
- 82.405.03 N° 3R

WARWICK-JAMES

- 82.410.01 N° 1
- 82.410.02 N° 2L
- 82.410.03 N° 3R

KOPP

- 82.414.01 N° 1
- 82.414.02 N° 2
- 82.414.03 N° 3
- 82.414.04 N° 4



WURZELHEBER
 ROOT ELEVATORS
 ELÉVATEURS DE RACINES
 ELEVADORES PARA RAÍCES
 LEVE PER RADICI



N° 1



N° 1



N° 1



N° 2

2 mm

2,5 mm

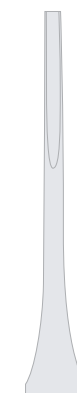

1

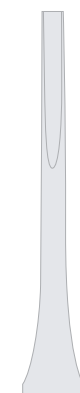

2

3 mm



3



N° 2L



N° 3R



N° 2L



N° 3R



N° 3 L



N° 4 R



1/4

FLOHR

82.501.01 N° 1
 82.501.02 N° 2L
 82.501.03 N° 3R



1/4

FRIEDMANN

82.505.01 N° 1
 82.505.02 N° 2L
 82.505.03 N° 3R



1/4

HYLIN

82.508.01 N° 1
 82.508.02 N° 2
 82.508.03 N° 3L
 82.508.04 N° 4R



1/4

COUPLAND

82.540.20 1
 82.540.25 2
 82.540.30 3



WURZELHEBER
 ROOT ELEVATORS
 ELÉVATEURS DE RACINES
 ELEVADORES PARA RAÍCES
 LEVE PER RADICI



WURZELHEBER
 ROOT ELEVATORS
 ELÉVATEURS DE RACINES
 ELEVADORES PARA RAÍCES
 LEVE PER RADICI



N° 0



N° 1

N° 2

N° 0A

N° 1A

N° 2A



N° 0



N° 1

N° 2

N° 0A

N° 1A

N° 2A



N° 0



N° 1

N° 2



1/4

BEIN

82.511.00 N° 0

82.511.01 N° 1

82.511.02 N° 2

82.512.00 N° 0

82.512.01 N° 1

82.512.02 N° 2

82.513.00 N° 0

82.513.01 N° 1

82.513.02 N° 2

82.514.00 N° 0A

82.514.01 N° 1A

82.514.02 N° 2A

82.515.00 N° 0A

82.515.01 N° 1A

82.515.02 N° 2A

WURZELHEBER
 ROOT ELEVATORS
 ELÉVATEURS DE RACINES
 ELEVADORES PARA RAÍCES
 LEVE PER RADICI



1/4

LOOS

82.525.01 N° 1L

82.525.02 N° 2R

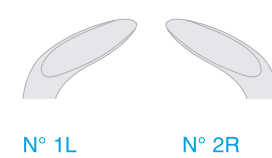

N° 1L

N° 2R



1/4

KRALLENHEBER

82.571.01 N° 1L

82.571.02 N° 2R

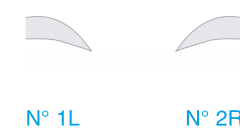

N° 1L

N° 2R



WURZELHEBER
 ROOT ELEVATORS
 ELÉVATEURS DE RACINES
 ELEVADORES PARA RAÍCES
 LEVE PER RADICI

WURZELHEBER
 ROOT ELEVATORS
 ELÉVATEURS DE RACINES
 ELEVADORES PARA RAÍCES
 LEVE PER RADICI

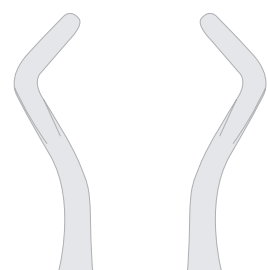

N° 1L N° 2R



N° 1



N° 320L N° 320R



N° 322L N° 322R



N° 370L N° 370R

1/4

POTT

82.567.01 N° 1L
 82.567.02 N° 2R

1/4

LECLUSE

82.561.01 N° 1

1/4

W. F. BARRY

82.533.20 N° 320L
 82.533.21 N° 320R
 82.533.22 N° 322L
 82.533.23 N° 322R
 82.533.70 N° 370L
 82.533.71 N° 370R



WURZELHEBER
 ROOT ELEVATORS
 ELÉVATEURS DE RACINES
 ELEVADORES PARA RAÍCES
 LEVE PER RADICI

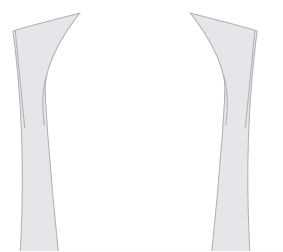

N° 11L N° 11R

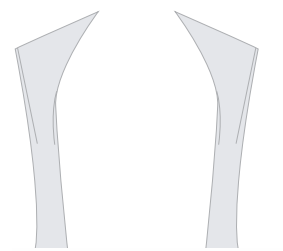

N° 13L N° 13R



N° 14L N° 14R



1/4

WINTER

- 82.551.05 N° 11L
- 82.551.08 N° 11R
- 82.553.05 N° 13L
- 82.553.08 N° 13R
- 82.554.05 N° 14L
- 82.554.08 N° 14R

WURZELSPITZENHEBER
 ROOT FRAGMENT ELEVATORS
 ELÉVATEURS POUR FRAGMENT DE RACINE
 ELEVADORES PARA FRAGMENTOS DE RAÍCES
 LEVE PER FRAMMENTI DE RADICI



1/4

HEIDBRINK

- 82.582.01 N° 1
- 82.582.02 N° 2L
- 82.582.03 N° 3R



N° 1



N° 2L



N° 3R



1/4

WEST-APIVICAL

- 82.583.09 N° 1



1/4

WEST HEIDBRINK-APIVICAL

- 82.587.01 N° 1



WURZELSPITZENHEBER
 ROOT FRAGMENT ELEVATORS
 ELÉVATEURS POUR FRAGMENT DE RACINE
 ELEVADORES PARA FRAGMENTOS DE RAÍCES
 LEVE PER FRAMMENTI DE RADICI

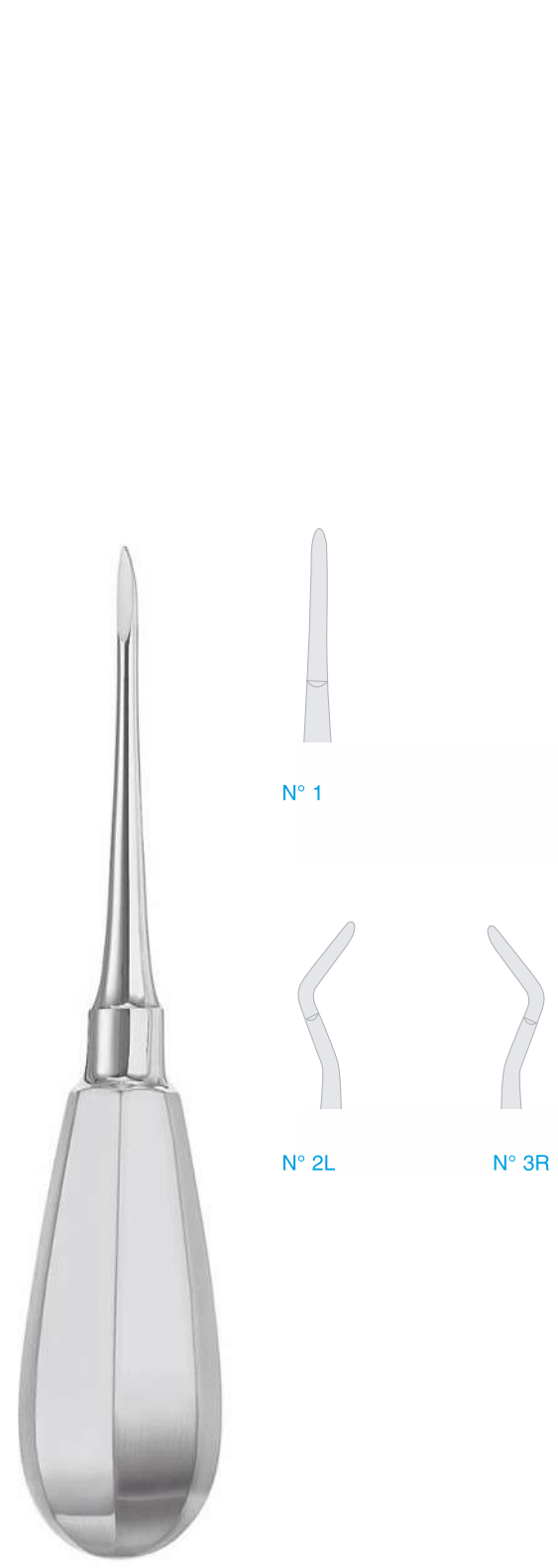

1/4
WINTER
 82.585.01 N° 1
 82.585.02 N° 2L
 82.585.03 N° 3R

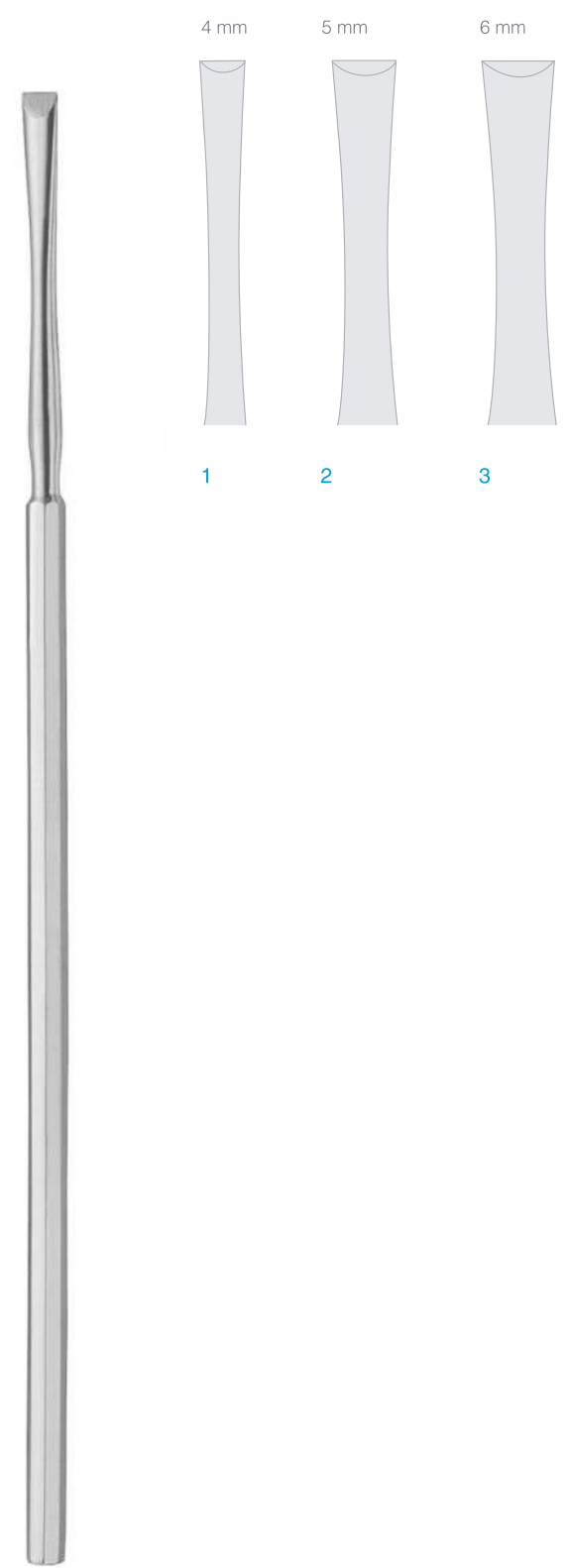

1/4
BARRY
 82.590.04 1
 82.590.05 2
 82.590.06 3

SYNDESMOTOME
 SYNDESMOTOMES
 SYNDESMOTOMES
 SINDESMÓTOMOS
 SINDESMOTOMI

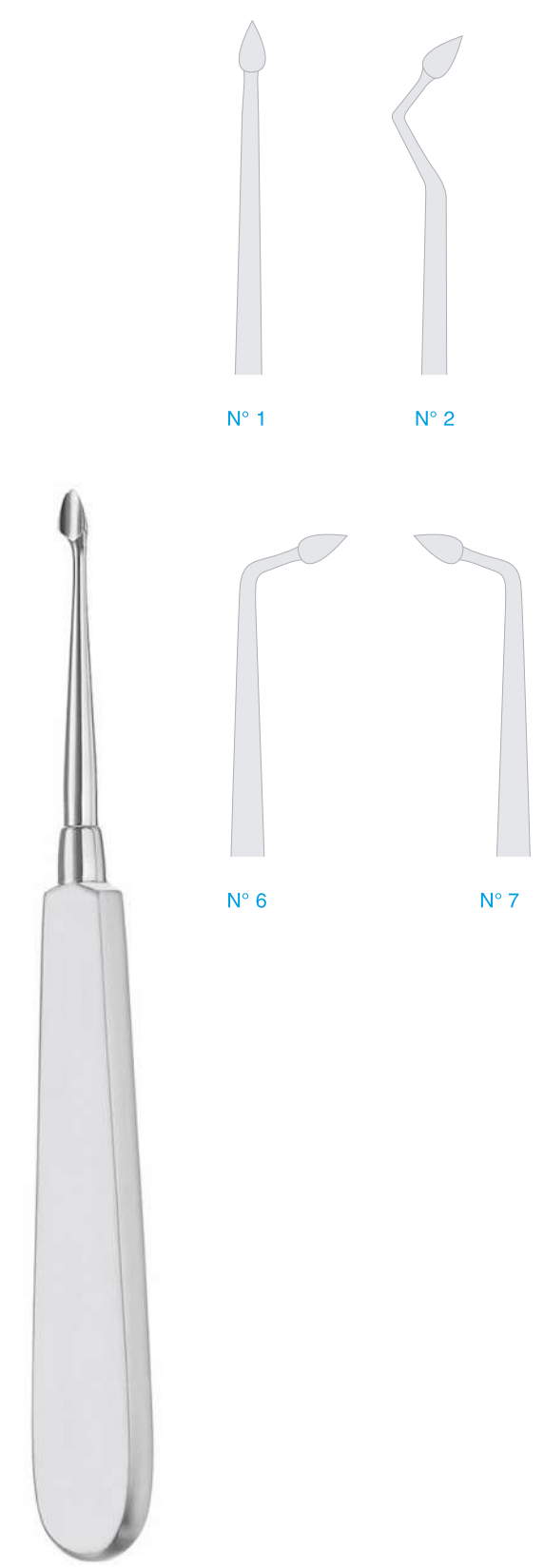

1/4
BERNARD
 82.581.01 N° 1
 82.581.02 N° 2
 82.581.06 N° 6
 82.581.07 N° 7



1/4
CHOMPRET
 82.577.01 N° 1
 82.577.02 N° 2
 82.577.03 N° 3
 82.577.04 N° 4



SYNDESMOTOME
SYNDESMOTOMES
SYNDESMOTOMES
SINDESMÓTOMOS
SINDESMOTOMI

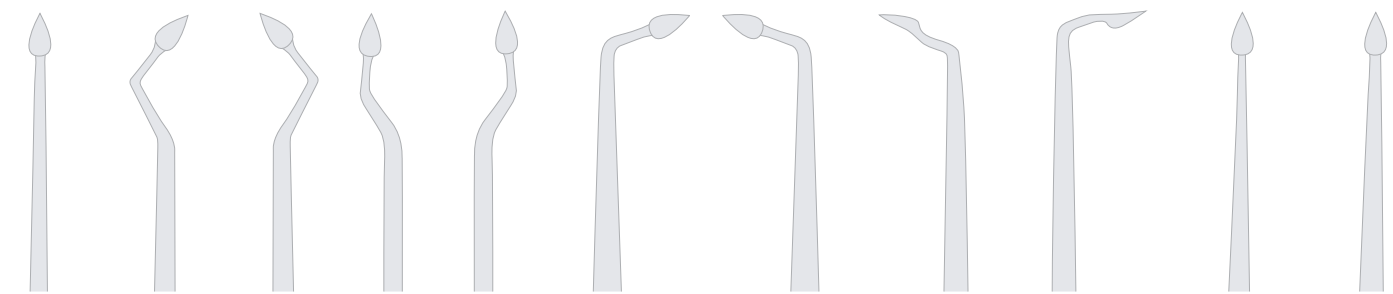

N° 1 N° 2L N° 3R N° 4L N° 5R N° 6L N° 7R N° 8 N° 9 N° 10 N° 11

82.580.01	N° 1	82.580.08	N° 8
82.580.02	N° 2L	82.580.09	N° 9
82.580.03	N° 3R	82.580.10	N° 10
82.580.04	N° 4L	82.580.11	N° 11
82.580.05	N° 5R		
82.580.06	N° 6L		
82.580.07	N° 7R		



1/1

BERNARD

82.580.90



1/1

BERNARD

82.580.91



BERNARD

82.580.00

Satz
set
set
juego
serie

82.580.99

nur Behälter
box only
seulement boîte
caja sola
scatola sola

14

- AMPULLENSPRITZEN
- CARTRIDGE SYRINGES
- SERINGUES POUR AMPOULE
- JERINGAS DE CARTUCHO
- SIRINGE DI CARPULE

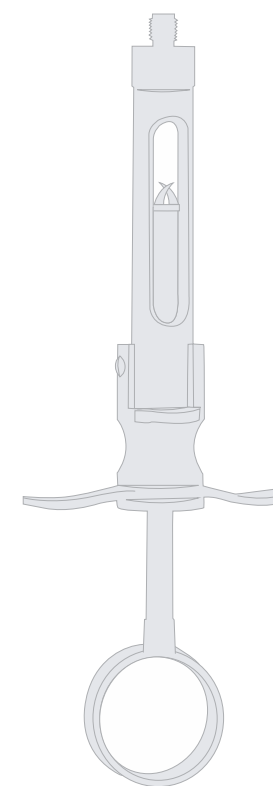



mit Aspiration
 with aspiration
 avec aspiration
 con aspiración
 con aspirazione

+ = inklusiv beider Aufsätze
 including both tips
 les deux embouts inclus
 ambos adaptadores incluidos
 ambedue addattatore incluso



82.603.51



82.603.52

metrisches Gewinde
 metric thread
 filetage métrique
 rosca métrica
 filettatura metrica



1/1

82.600.18 1,8 ml +
 82.600.22 2,2 ml +

metrisches Gewinde
 metric thread
 filetage métrique
 rosca métrica
 filettatura metrica



1/1

82.601.18 1,8 ml +
 82.601.22 2,2 ml +

metrisches Gewinde
 metric thread
 filetage métrique
 rosca métrica
 filettatura metrica



1/1

82.611.18 1,8 ml

US-Gewinde
 US thread
 filetage américain
 rosca tipo US
 filettatura tipo US



1/1

82.609.18 1,8 ml
 82.609.22 2,2 ml

US-Gewinde
 US thread
 filetage américain
 rosca tipo US
 filettatura tipo US



1/1

82.608.18 1,8 ml
 82.608.22 2,2 ml

metrisches Gewinde
 metric thread
 filetage métrique
 rosca métrica
 filettatura metrica



AMPULLENSPRITZEN
 CARTRIDGE SYRINGES
 SERINGUES POUR AMPOULE
 JERINGAS DE CARTUCHO
 SIRINGE DI CARPULE

ohne Aspiration
 without aspiration
 sans aspiration
 sin aspiración
 senza aspirazione

AMPULLENSPRITZEN
 CARTRIDGE SYRINGES
 SERINGUES POUR AMPOULE
 JERINGAS DE CARTUCHO
 SIRINGE DI CARPULE



1/1

1/1

1/1

82.606.18	1,8 ml
82.606.22	2,2 ml

82.602.18	1,8 ml	+
82.602.22	2,2 ml	+

82.603.18	1,8 ml	+
82.603.22	2,2 ml	+

82.610.42	17 x 42
-----------	---------

US-Gewinde
 US thread
 filetage américain
 rosca tipo US
 filettatura tipo US

metrisches Gewinde
 metric thread
 filetage métrique
 rosca métrica
 filettatura metrica

metrisches Gewinde
 metric thread
 filetage métrique
 rosca métrica
 filettatura metrica

12 Ampullennadeln
 12 cartridge needles
 12 aiguilles pour ampoules
 12 agujas para cartucho
 12 aghi per carpule



AMPULLENSPRITZEN
 CARTRIDGE SYRINGES
 SERINGUES POUR AMPOULE
 JERINGAS DE CARTUCHO
 SIRINGE DI CARPULE



1/1

82.652.01



1/1

82.652.00

selbstfüllend, Metall
 self filling, metal
 autoremplissant, métallique
 relleno automático, metálica
 riempire automatico, metallica



82.661.00

Luftbläser
 air blower
 souffleur d'air
 soplador de aire
 soffiatore d'aria

15

- MUNDSPIEGEL
 MOUTH MIRRORS
 MIROIRS DENTAIRES
 ESPEJOS DE BOCA
 SPECCHIETTI DI BOCCA

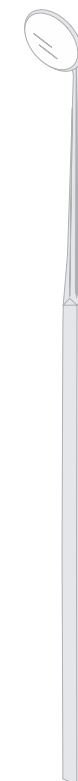



flach
plane
plat
plano
plano

hohl, wirkt vergrößernd
concave, enlarging effect
creux, avec effet agrandissant
cóncavo, con efecto de aumento
cavo, con effetto di ingrandimento

metrisches Gewinde
metric thread
filetage métrique
rosca métrica
filettatura metrica

82.702.16	16 mm	N° 1
82.702.20	20 mm	N° 3
82.702.22	22 mm	N° 4
82.702.24	24 mm	N° 5

82.703.22	22 mm	N° 4
82.703.24	24 mm	N° 5



flach
plane
plat
plano
plano

hohl, wirkt vergrößernd
concave, enlarging effect
creux, avec effet agrandissant
cóncavo, con efecto de aumento
cavo, con effetto di ingrandimento

Vorderseite Rhodium beschichtet
front side rhodium plated
devant revêtu de rhodium
parte anterior con revestimiento de rodio
lato anteriore con rivestimento in rodio

mit konischem Gewindeauslauf
with conical end of thread
avec extrémité filetée conique
con terminal cónica de rosca
con filettatura a estremità conica

82.704.20	20 mm	N° 3
82.704.22	22 mm	N° 4
82.704.24	24 mm	N° 5

82.705.20	20 mm	N° 3
82.705.22	22 mm	N° 4
82.705.24	24 mm	N° 5

82.706.20	20 mm	N° 3
82.706.22	22 mm	N° 4
82.706.24	24 mm	N° 5

konisches Gewinde
conical thread
filetage conique
rosca cónica
filettatura conico

leichtes Modell
light model
modèle légé
módulo modelo ligero
modello leggero

metrisches Gewinde
metric thread
filetage métrique
rosca métrica
filettatura metrica

leichtes Modell
light model
modèle légé
módulo modelo ligero
modello leggero



1/1

82.721.14 13,5 cm|5 1/4" 
ø 7 mm



1/1

82.721.04 13,5 cm|5 1/4" 
ø 7 mm



1/1

82.726.01 12 cm|4 3/4" 
ø 7 mm

metrisches Gewinde
metric thread
filetage métrique
rosca métrica
filettatura metrica



82.728.00	12 cm 4 3/4"	82.728.01	12 cm 4 3/4"	82.730.01	12 cm 4 3/4"	82.731.00	12 cm 4 3/4"
ø 5 mm		ø 5 mm		ø 5 mm		ø 5 mm	

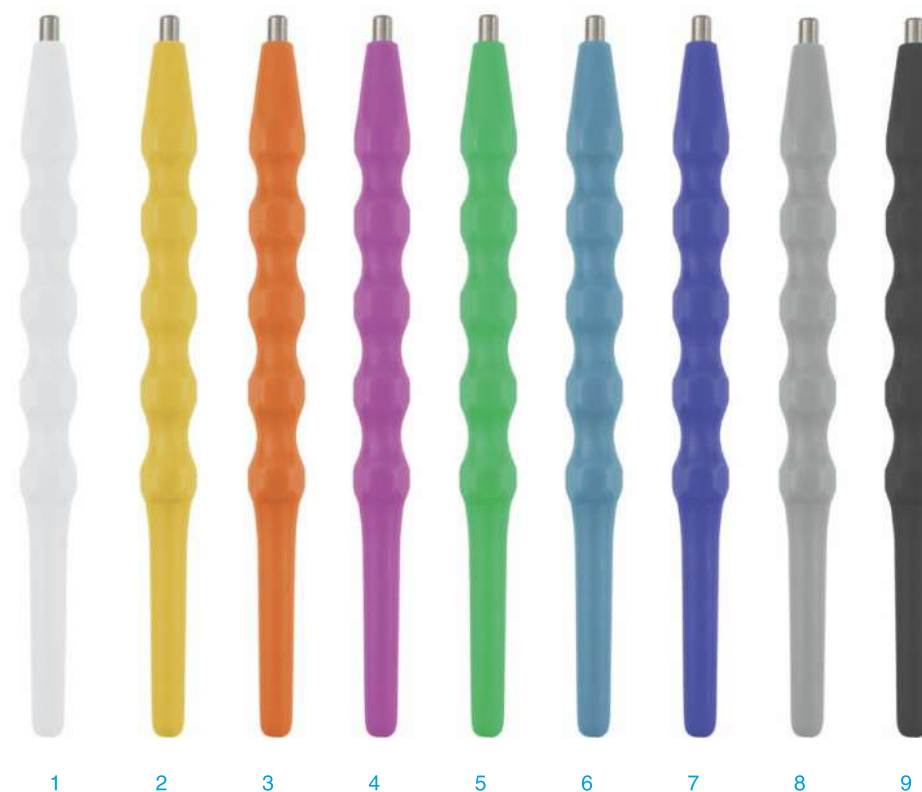

82.738.01	13,5 cm 5 1/4"	1
82.738.02	13,5 cm 5 1/4"	2
82.738.03	13,5 cm 5 1/4"	3
82.738.04	13,5 cm 5 1/4"	4
82.738.05	13,5 cm 5 1/4"	5
82.738.06	13,5 cm 5 1/4"	6
82.738.07	13,5 cm 5 1/4"	7
82.738.08	13,5 cm 5 1/4"	8
82.738.09	13,5 cm 5 1/4"	9

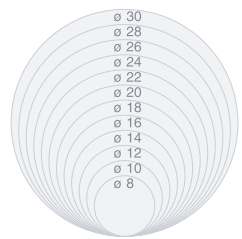

52.270.08	8 mm	N° 00
52.270.10	10 mm	N° 0
52.270.12	12 mm	N° 1
52.270.14	14 mm	N° 2
52.270.16	16 mm	N° 3
52.270.18	18 mm	N° 4
52.270.20	20 mm	N° 5
52.270.22	22 mm	N° 6
52.270.24	24 mm	N° 7
52.270.26	26 mm	N° 8
52.270.28	28 mm	N° 9
52.270.30	30 mm	N° 10

52.272.08	8 mm	N° 00
52.272.10	10 mm	N° 0
52.272.12	12 mm	N° 1
52.272.14	14 mm	N° 2
52.272.16	16 mm	N° 3
52.272.18	18 mm	N° 4
52.272.20	20 mm	N° 5
52.272.22	22 mm	N° 6
52.272.24	24 mm	N° 7
52.272.26	26 mm	N° 8
52.272.28	28 mm	N° 9
52.272.30	30 mm	N° 10

52.276.10

16

- PARODONTOLOGIE
- PERIODONTOLOGY
- PARODONTOLOGIE
- PERIODONCIA
- PARODONTOLOGIA



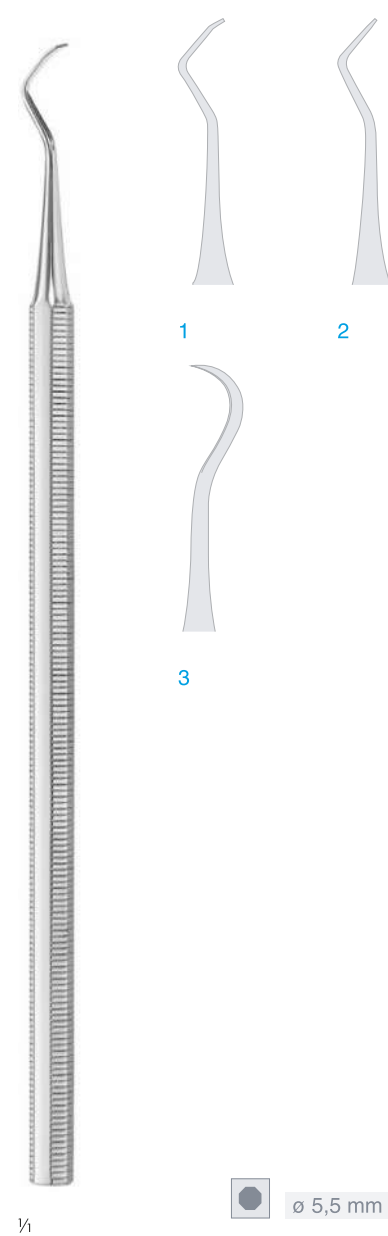

- 83.230.01 1 WILLIGER
83.231.01 2 WILLIGER
83.237.00 3 BLACK

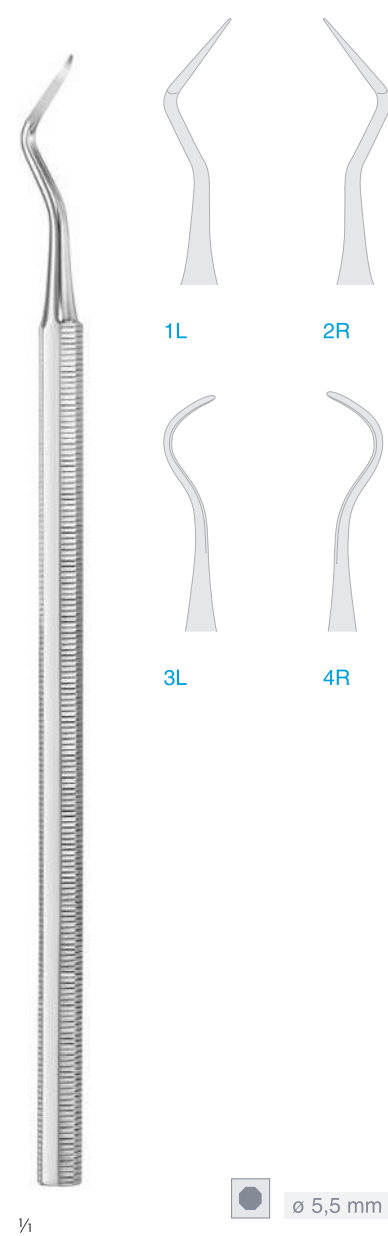

- MUEHLEMANN
83.239.01 1L
83.239.02 2R
83.243.01 3L
83.243.02 4R

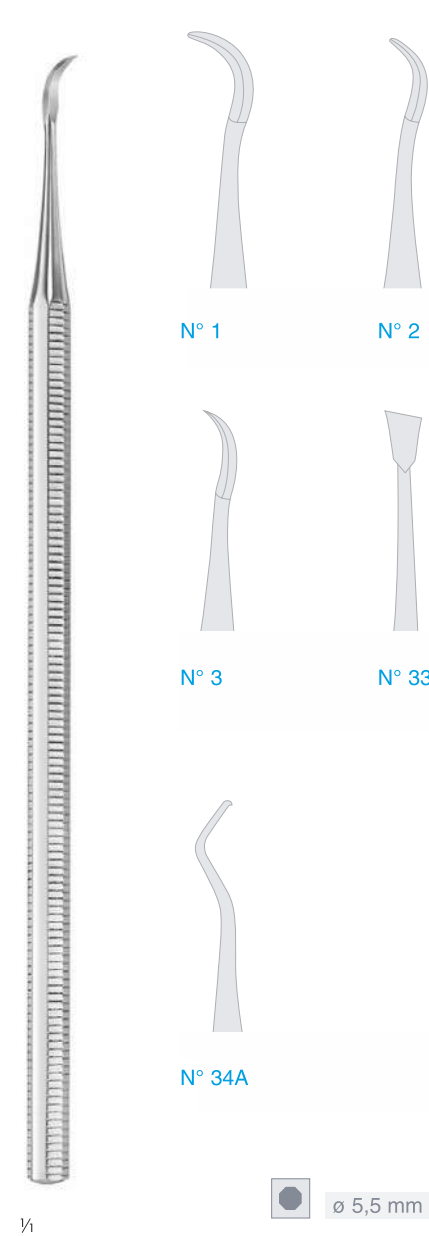

- 83.245.01 N° 1
83.245.02 N° 2
83.245.03 N° 3
83.245.33 N° 33
83.245.38 N° 34A

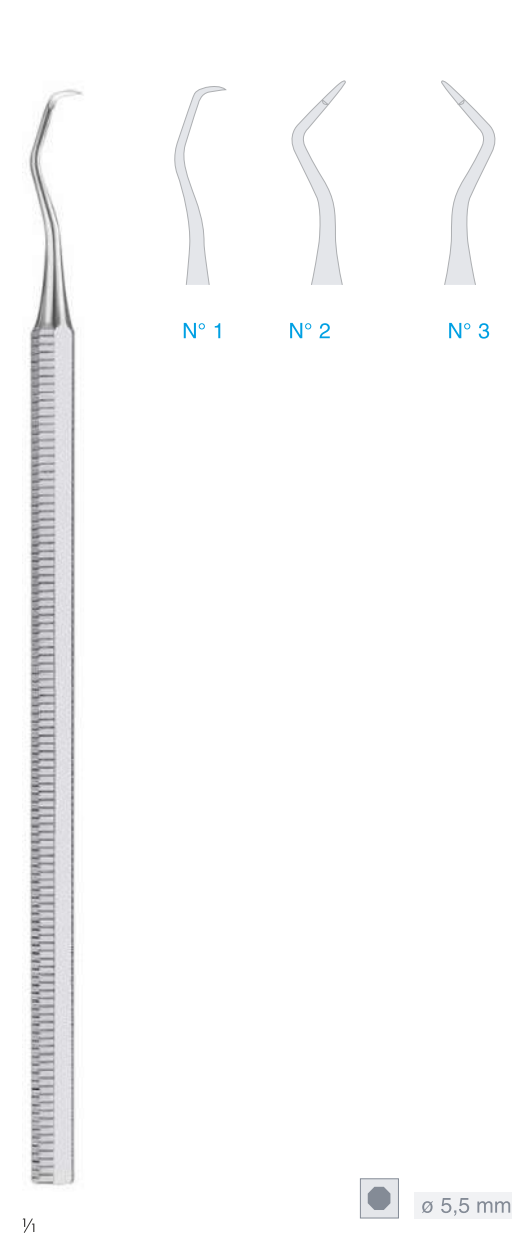

- 83.250.01 N° 1
83.250.02 N° 2
83.250.03 N° 3
83.250.04 N° 4
83.250.05 N° 5
83.250.06 N° 6
83.250.07 N° 7
83.250.08 N° 8



- 83.250.00
Satz aus 8 Stück
set of 8 pieces
set de 8 pièces
set de 8 pezas
set di 8 pezzi

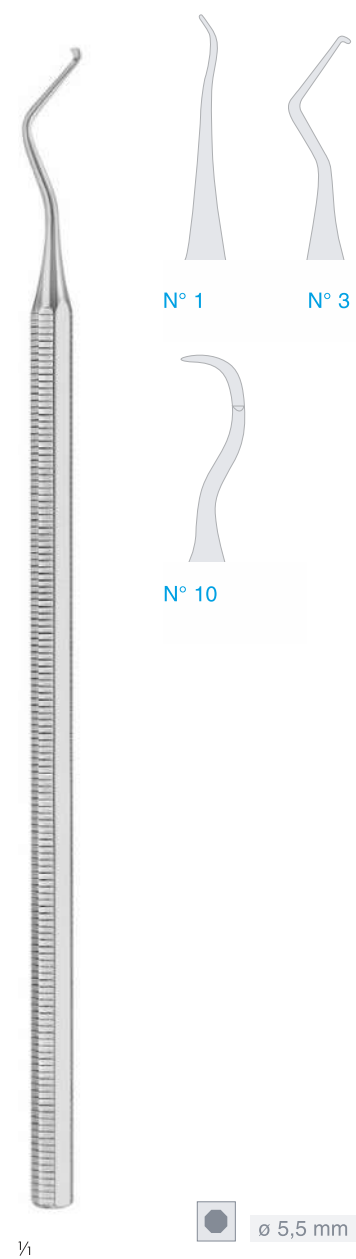

83.277.01 MCCALL N° 1
83.277.03 MCCALL N° 3
83.277.10 MCCALL N° 10

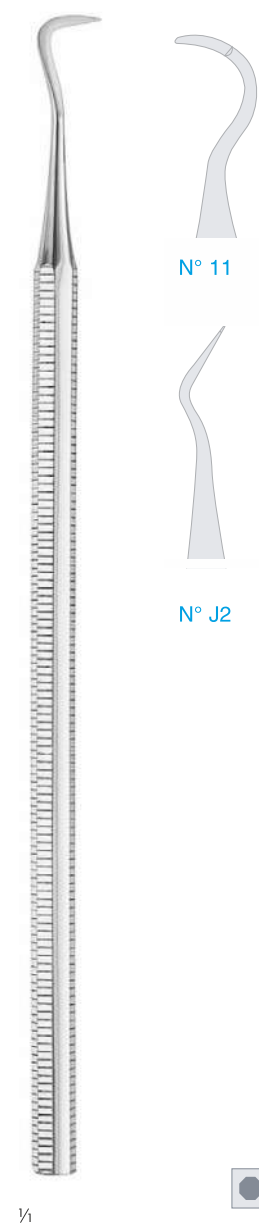

83.251.11 DARBY-PERRY N° 11
83.271.02 JACQUETTE N° J2

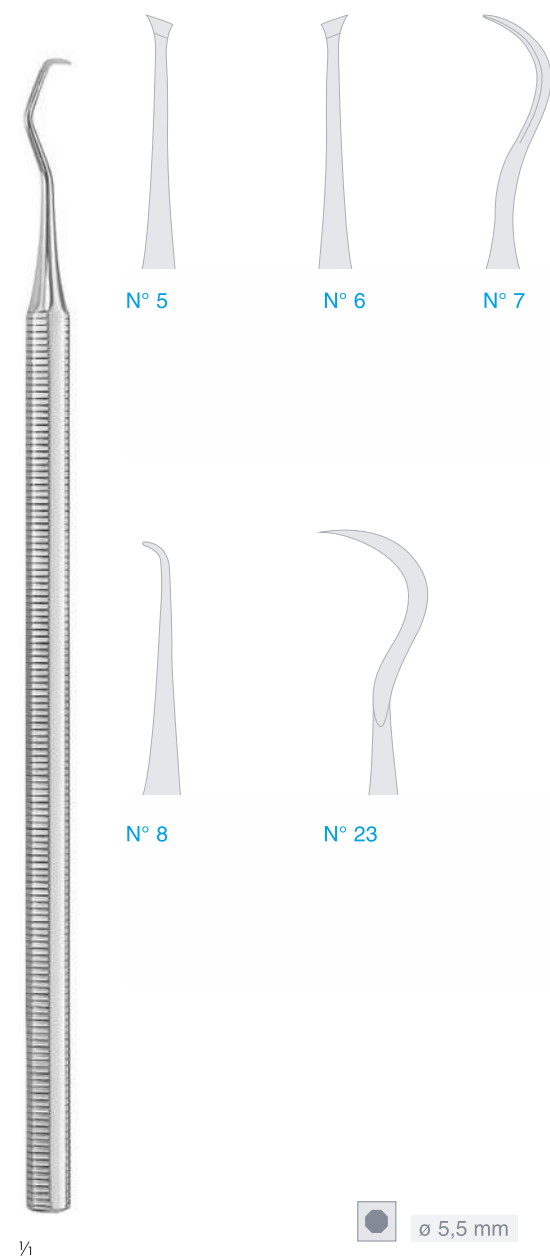

83.301.05 SCHARMANN N° 5
83.301.06 SCHARMANN N° 6
83.301.07 SCHARMANN N° 7
83.301.08 SCHARMANN N° 8
83.307.23 SICHEL N° 23

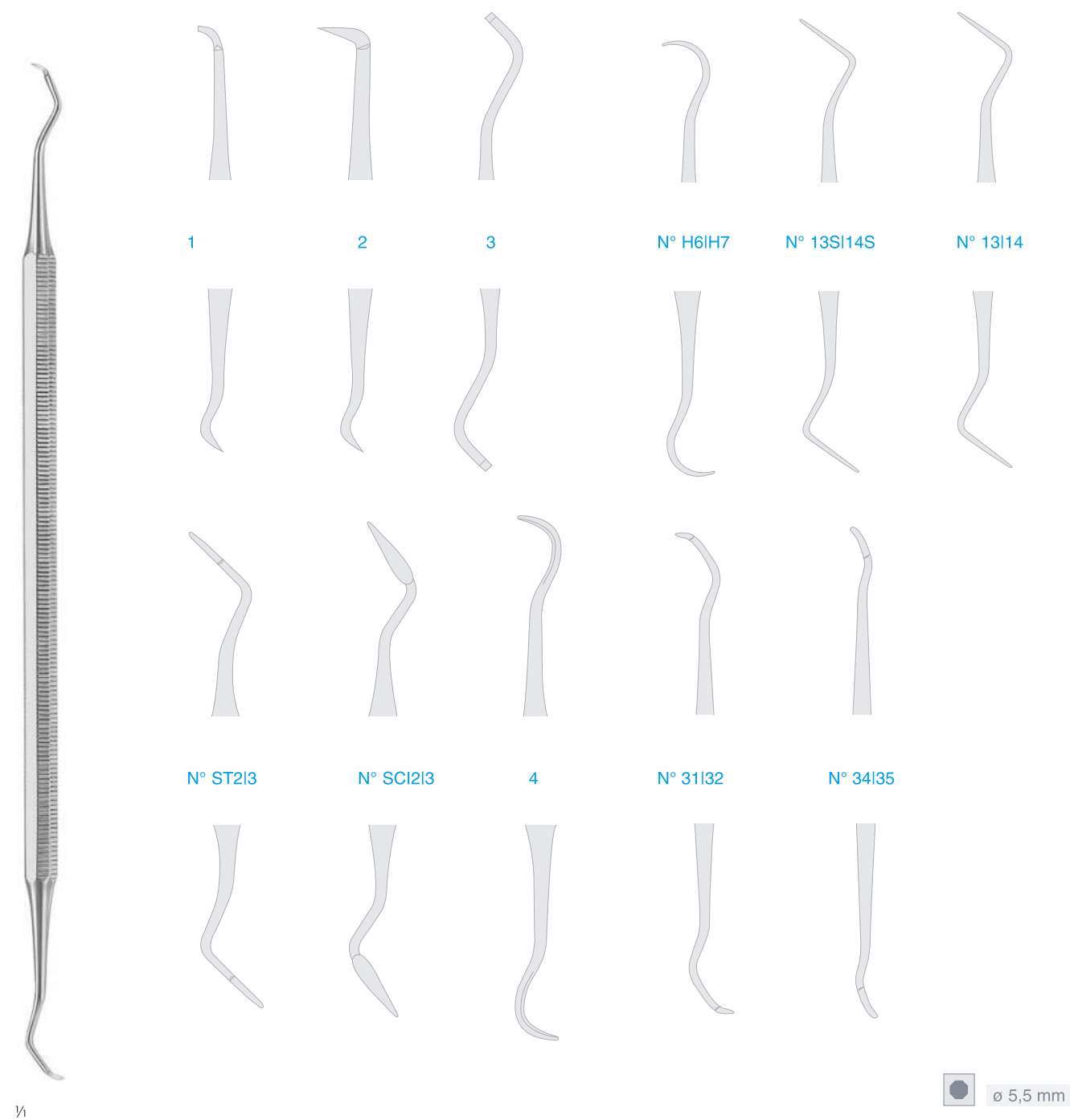

83.282.02 CUMINE 1
83.283.02 MITCHELL 2
83.292.29 3
83.293.01 TAYLOR N° ST2I3
83.293.02 N° SCI2I3
83.296.04 YOUNGER-GOOD 4

83.312.07 HYGIENIST N° H6IH7
83.312.13 MCCALL N° 13SI14S
83.312.14 MCCALL N° 13I14
83.312.02 JACQUETTE N° 31I32
83.312.03 JACQUETTE N° 34I35

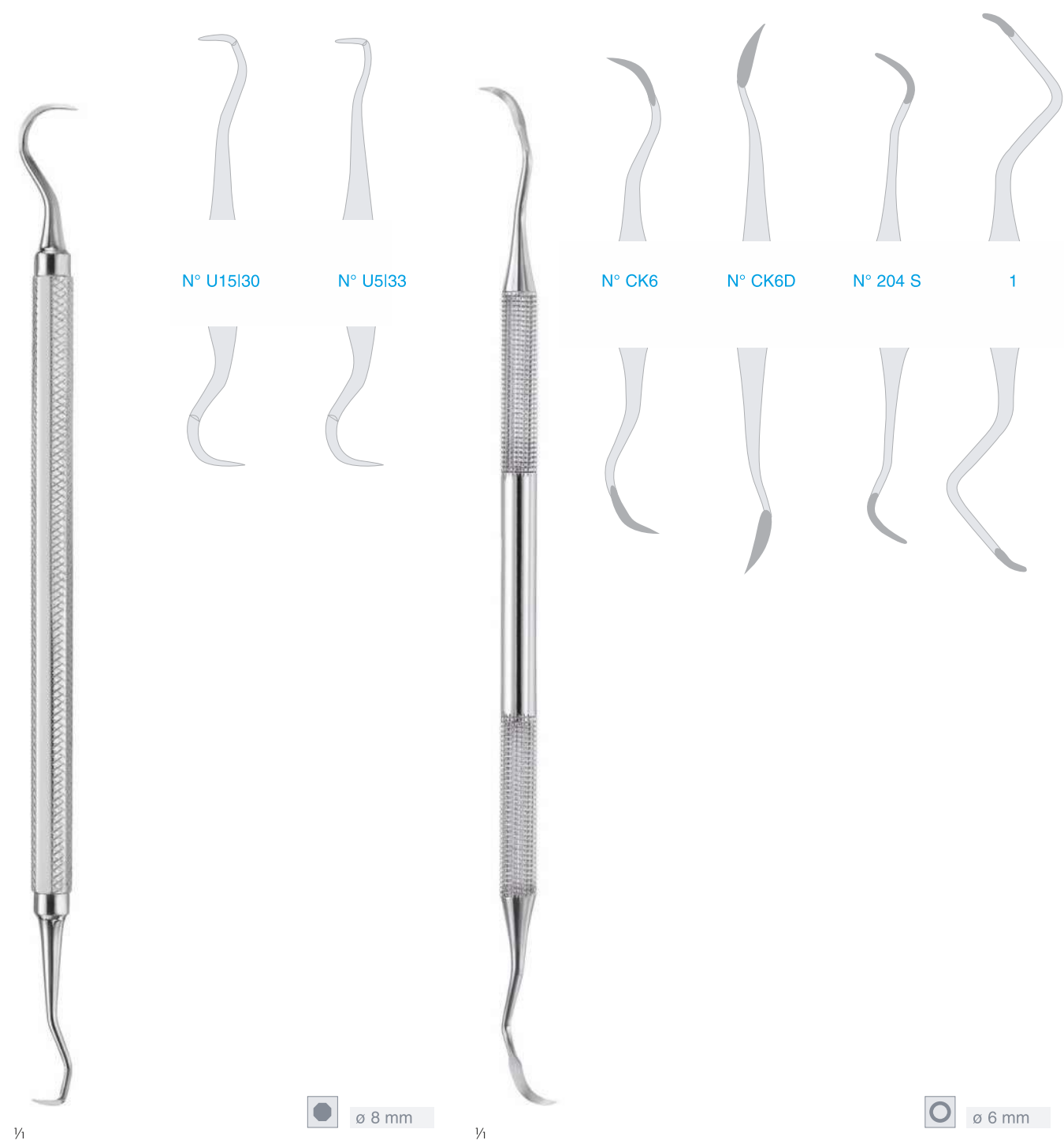

83.308.30 TOWNER-JACQUETTE N° U15130

83.308.33 TOWNER-JACQUETTE N° U5133

83.328.06 CRANE-KAPLAN N° CK6

83.328.61 CRANE-KAPLAN N° CK6D

83.329.24 N° 204S

83.330.00 PRICHARD 1

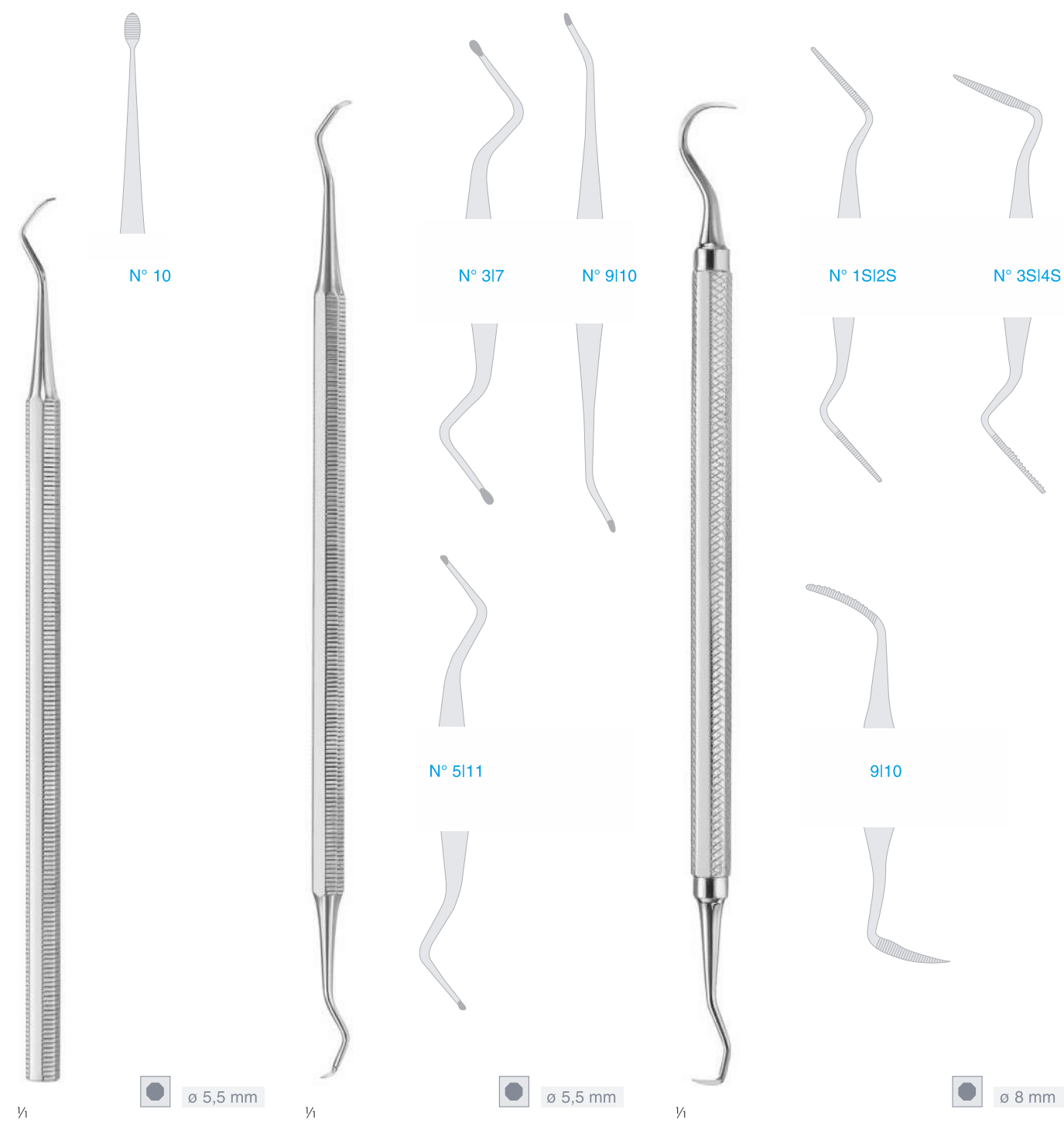

83.317.10 BUNTING N° 10

83.315.07 HIRSCHFELD N° 317

83.315.10 HIRSCHFELD N° 9110

83.315.11 HIRSCHFELD N° 511

83.316.02 SUGARMAN N° 1S12S

83.316.03 SUGARMAN N° 3S14S

83.316.19 SCHLUGER 9110

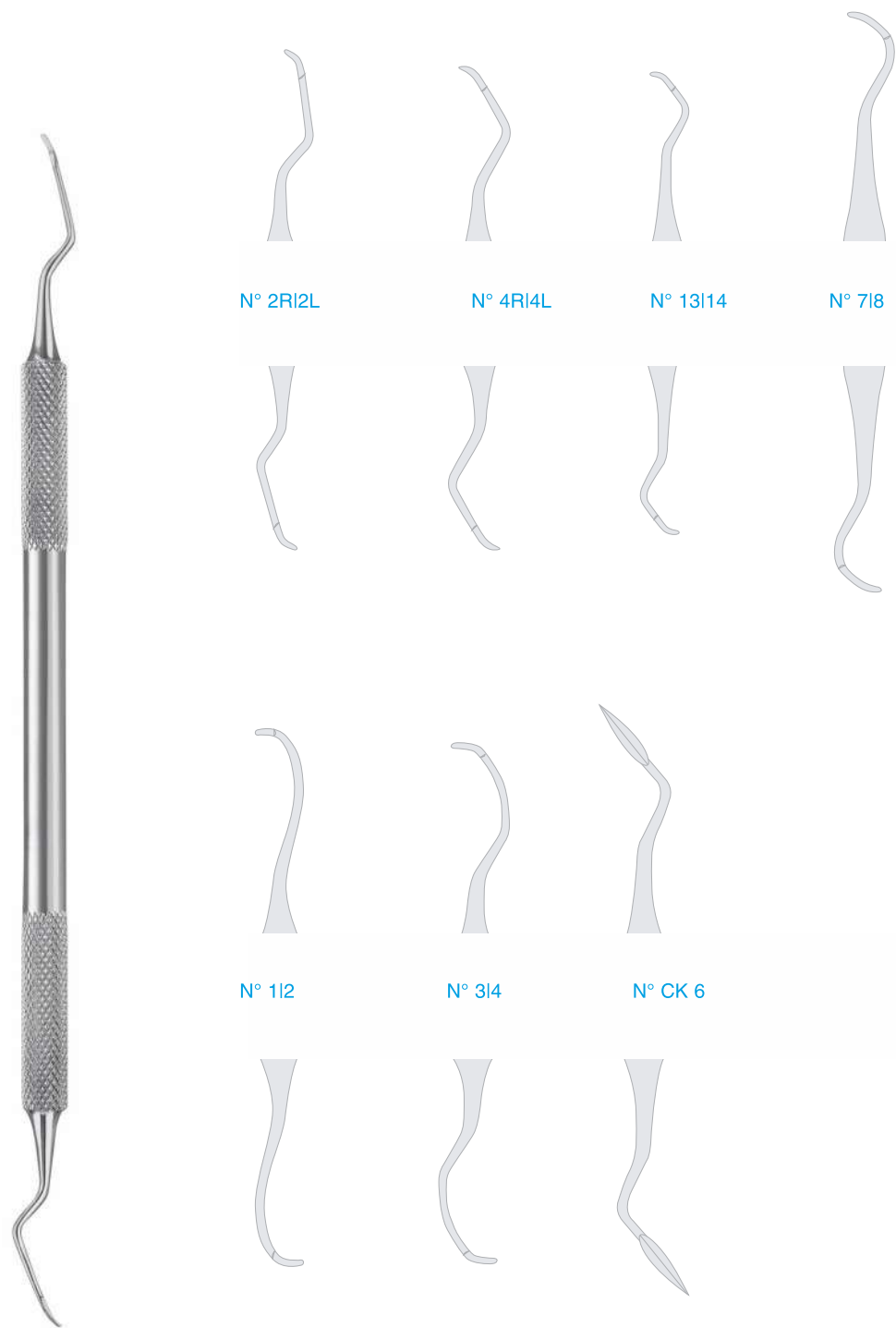

⊙ ø 6 mm

83.290.02	COLUMBIA	N° 2RI2L
83.290.04	COLUMBIA	N° 4RI4L
83.290.14	COLUMBIA	N° 13I14
83.291.08	YOUNGER-GOOD	N° 7I8
83.295.02	LANGER	N° 1I2
83.295.04	LANGER	N° 3I4
83.293.06	CRANE-KAPLAN	N° CK 6



⊙ ø 6 mm

GOLDMAN-FOX

83.326.01	N° 1	83.326.07	N° 7
83.326.02	N° 2	83.326.08	N° 8
83.326.03	N° 3	83.326.09	N° 9
83.326.04	N° 4	83.326.10	N° 10
83.326.05	N° 5	83.326.11	N° 11
83.326.06	N° 6	83.326.21	N° 21



N° 112 N° 314 N° 516 N° 718 N° 9110

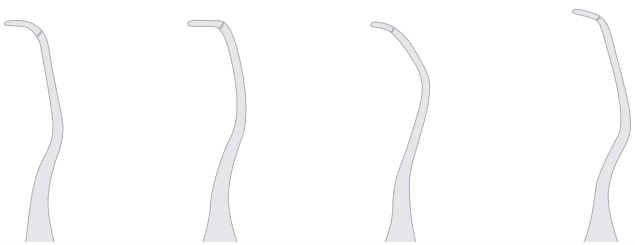

N° 11112 N° 12113 N° 13114 N° 15116



∅ 6 mm

1/4

GRACEY

83.327.02	N° 112	83.327.12	N° 11112
83.327.04	N° 314	83.327.13	N° 12113
83.327.06	N° 516	83.327.14	N° 13114
83.327.08	N° 718	83.327.16	N° 15116
83.327.10	N° 9110		



N° 112 N° 314 N° 516 N° 718 N° 9110

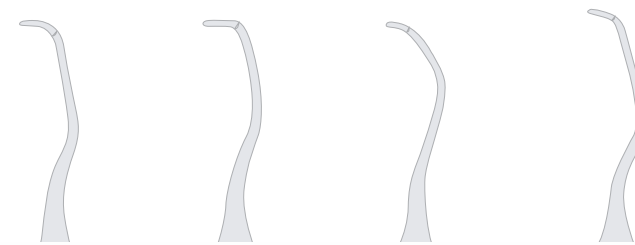

N° 11112 N° 12113 N° 13114 N° 15116



∅ 9,5 mm

1/4

GRACEY

83.327.02H1	N° 112	83.327.12H1	N° 11112
83.327.04H1	N° 314	83.327.13H1	N° 12113
83.327.06H1	N° 516	83.327.14H1	N° 13114
83.327.08H1	N° 718	83.327.16H1	N° 15116
83.327.10H1	N° 9110		

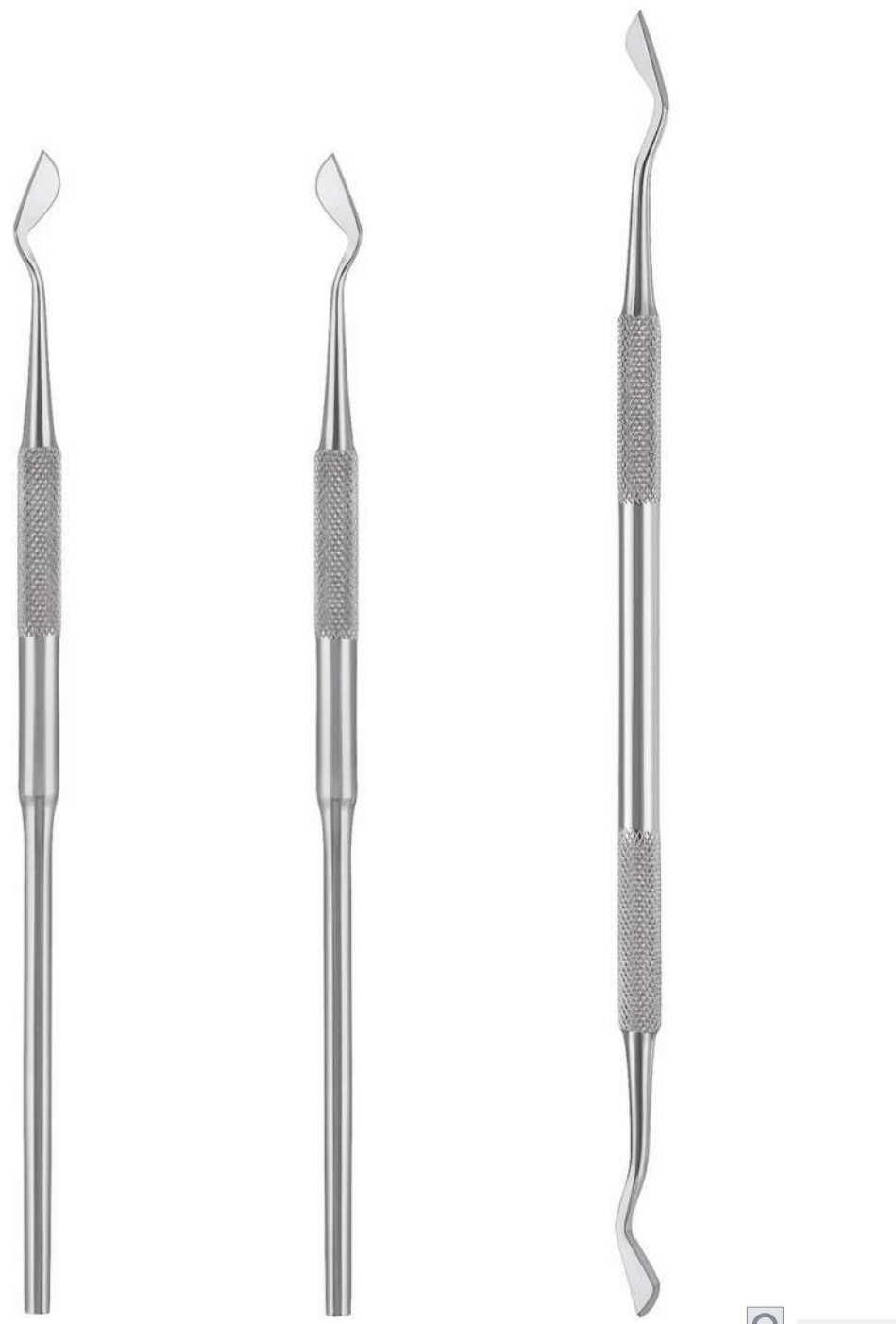

1/1
 KIRKLAND
 83.331.15 N° 15

1/1
 KIRKLAND
 83.331.16 N° 16

1/1
 KIRKLAND
 83.332.16 N° 15/16

∅ 6 mm



1/1
 ORBAN
 83.339.02 N° 2

1/1
 ORBAN
 83.340.22 N° 22



N° 2



N° 22

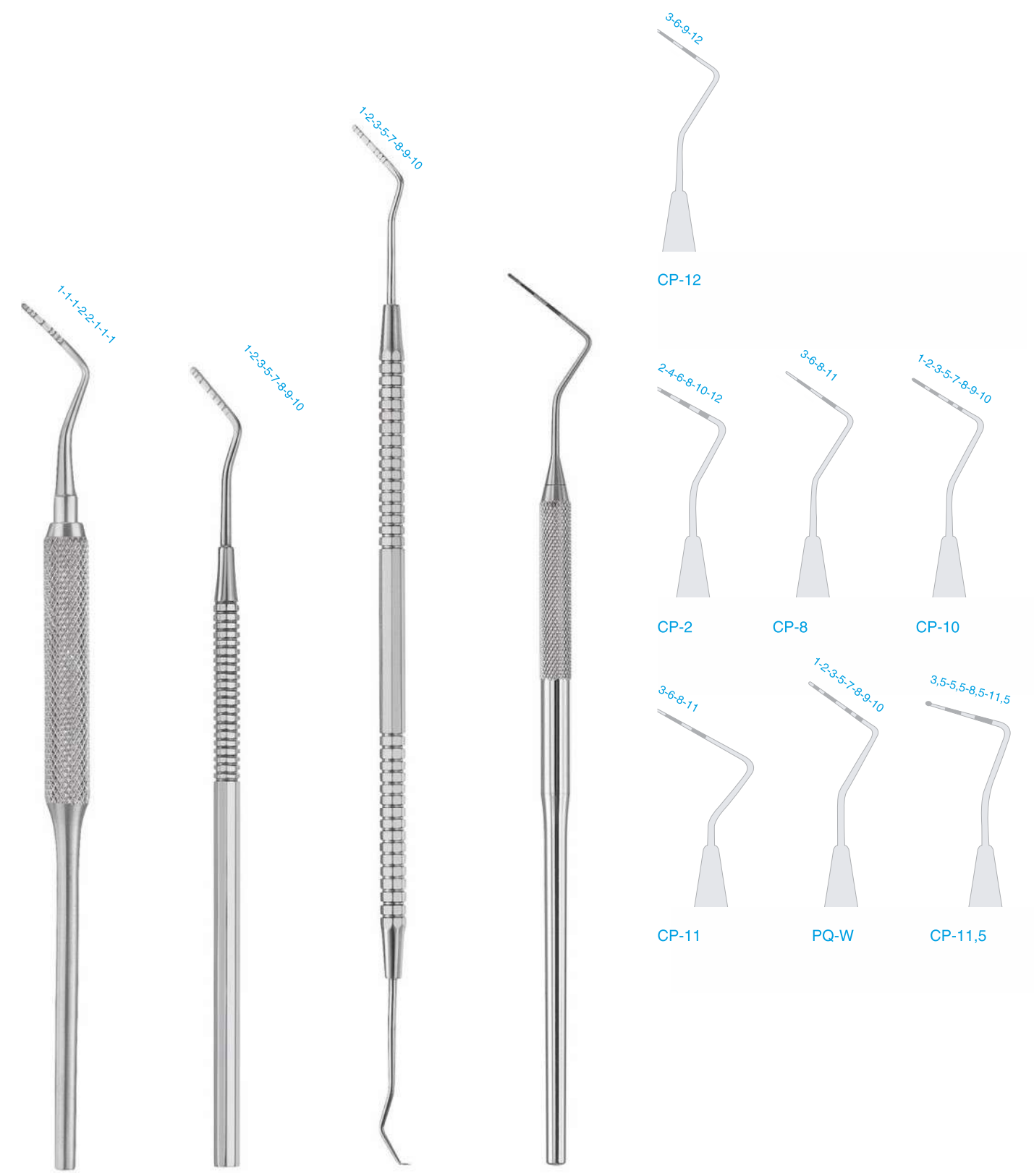

1/1
 83.344.01

1/1
 83.345.01

1/1
 83.346.01

1/1
 83.352.12 CP-12

1/1
 83.352.02 CP-2

1/1
 83.352.08 CP-8

1/1
 83.352.10 CP-10

1/1
 83.352.11 N° 11 CP-11

1/1
 83.354.00 WILLIAMS PQ-W

1/1
 83.355.00 WHO CP-11,5

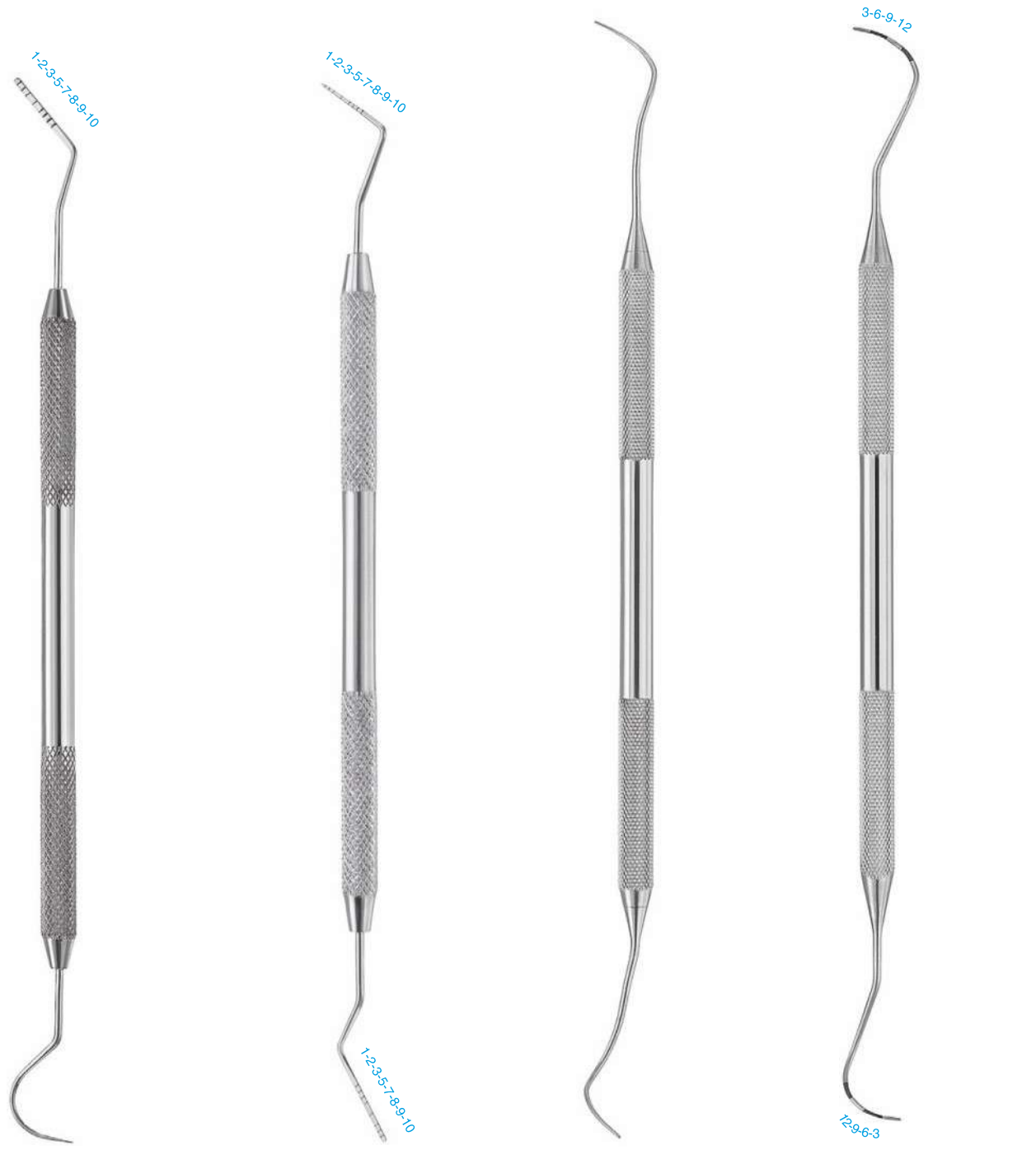

1/4
GOLDMAN-FOX
 83.346.02 N° 23GF

1/4
WILLIAM-FOX
 83.346.10

1/4
NABERS
 83.357.02 N° 2N

1/4
NABERS
 83.358.02 N° Q2N



1/4
CLEOIDS-DISCOIDS
 83.362.01 N° 112
 83.362.11 N° 110

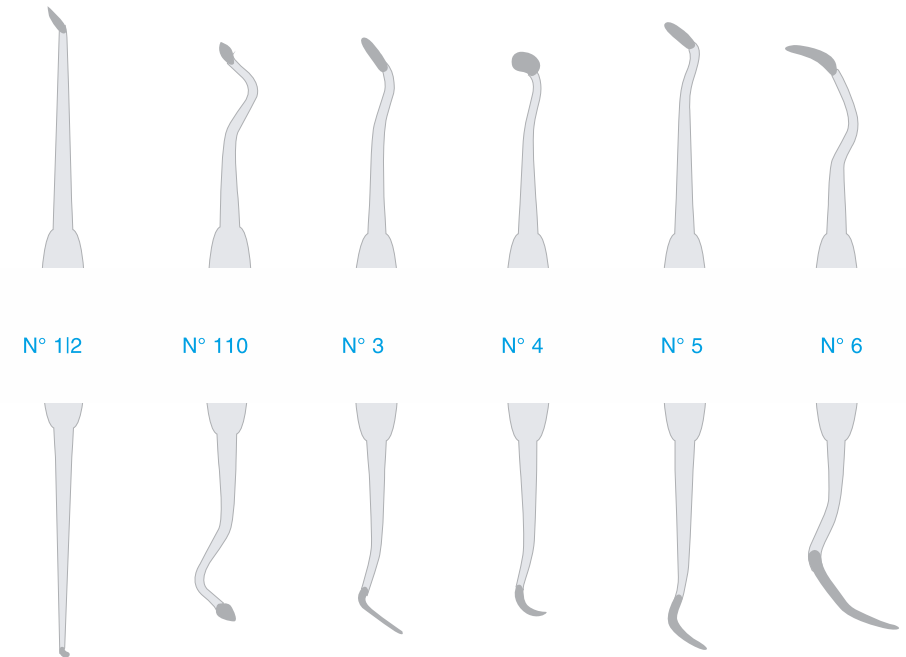

TANNER
 83.363.03 N° 3
 83.363.04 N° 4
 83.363.05 N° 5
 83.363.06 N° 6

⊙ ø 6 mm

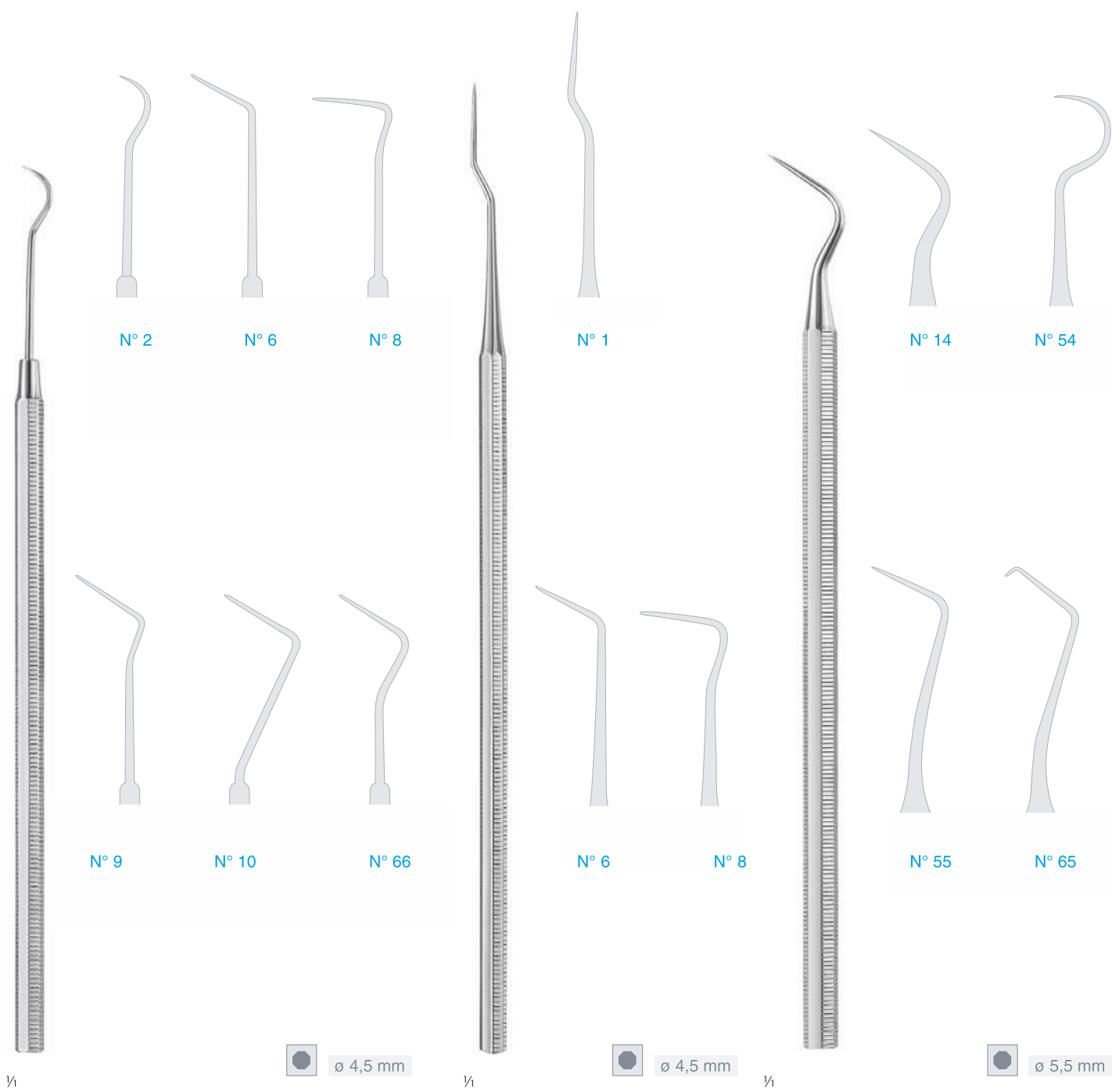

- 83.391.02 N° 2
- 83.391.06 N° 6
- 83.391.08 N° 8
- 83.391.09 N° 9
- 83.391.10 N° 10
- 83.391.66 N° 66

- 83.394.01 N° 1
- 83.394.06 N° 6
- 83.394.08 N° 8

- 83.397.14 N° 14
- 83.397.54 N° 54
- 83.397.55 N° 55
- 83.397.65 N° 65



WHITE

- 83.401.01 N° 1
- 83.401.02 N° 2
- 83.401.03 N° 3
- 83.401.05 N° 5
- 83.401.06 N° 6
- 83.401.07 N° 7
- 83.401.08 N° 8
- 83.401.23 N° 23
- 83.401.42 N° 42

- 83.405.03 N° 3
- 83.405.23 SHEPHERD N° 23
- 83.405.54 N° 54
- 83.405.06 N° 6A

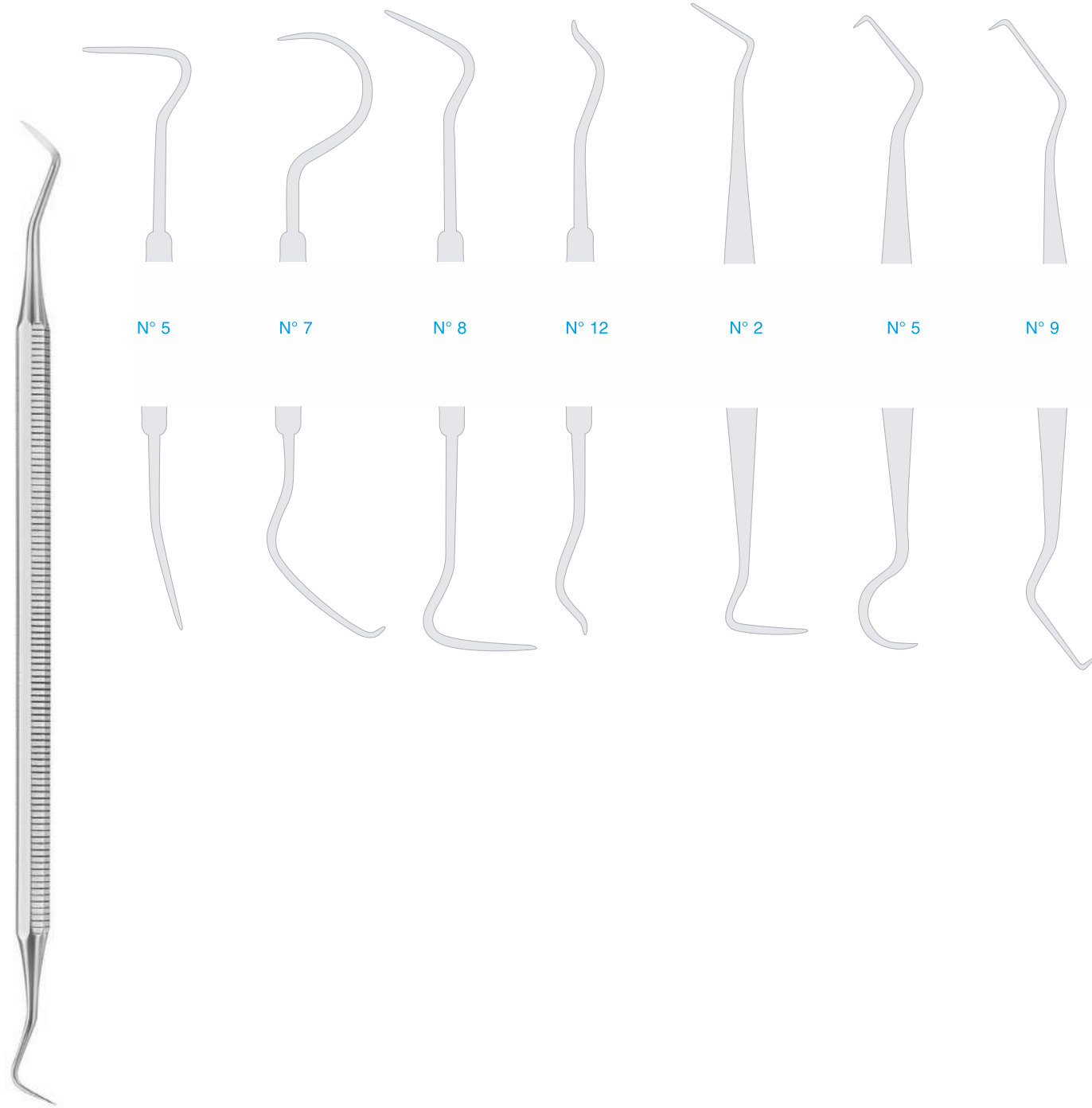

N° 5 N° 7 N° 8 N° 12 N° 2 N° 5 N° 9

● ø 5,5 mm

- 83.392.05 N° 5
- 83.392.07 N° 7
- 83.392.08 N° 8
- 83.392.12 WESTON N° 12

- 83.421.02 N° 2
- 83.421.05 N° 5
- 83.421.09 N° 9

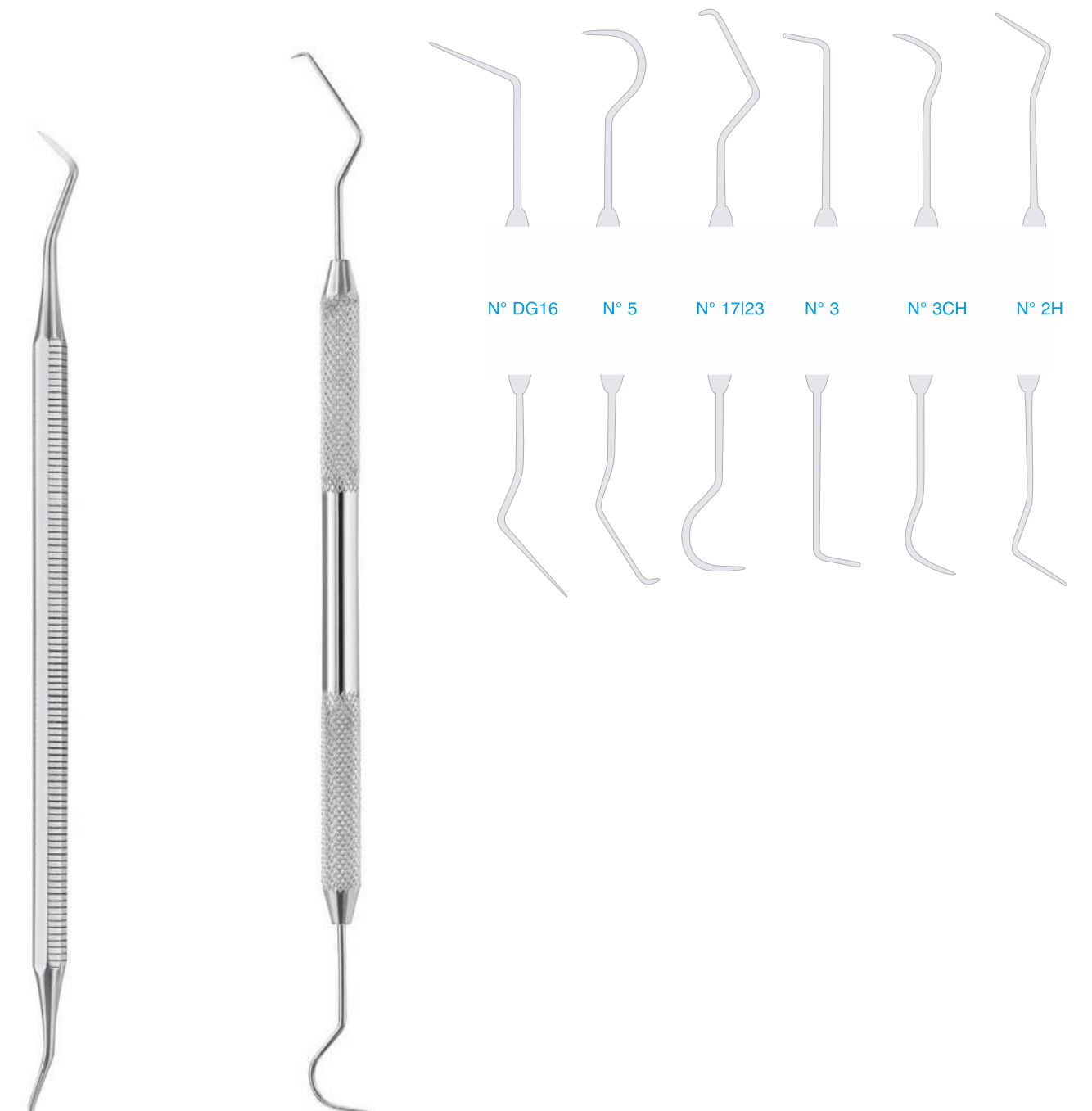

N° DG16 N° 5 N° 17123 N° 3 N° 3CH N° 2H

● ø 5,5 mm

○ ø 6 mm

- LANGE
- 83.399.01 N° 1

- 83.439.16 N° DG16
- 83.440.05 N° 5
- 83.441.17 WILKINS-TUFTS N° 17123
- 83.442.03 N° 3
- 83.443.03 N° 3CH
- 83.444.02 N° 2H



N° 17118 N° 19120

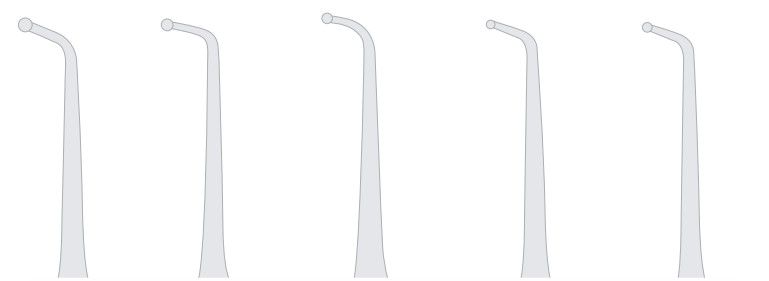

N° 1131114 N° 1151116 N° 1171118 N° 1191120 N° 1211122



N° 1411142 N° 1591160 N° 1611162 N° 1651166



N° 5 N° 13 N° 14 N° 15

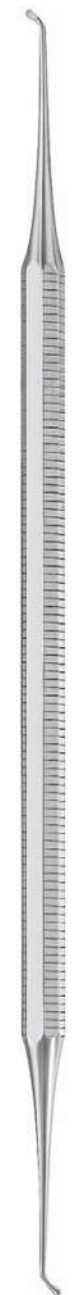

N° 21122



N° 1231124 N° 1251126 N° 1271128 N° 1291130 N° 1311132 N° 1331134

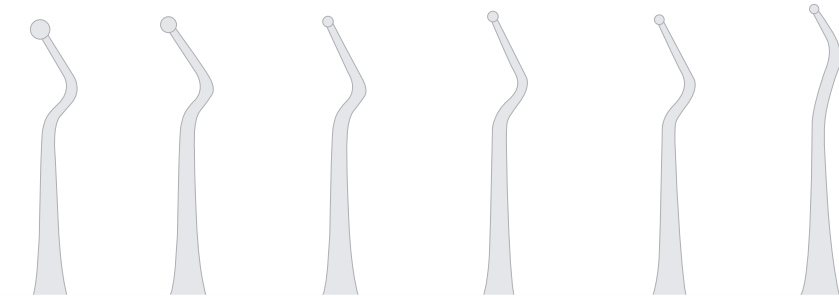

N° 1711172 N° 1731174 N° 1751176

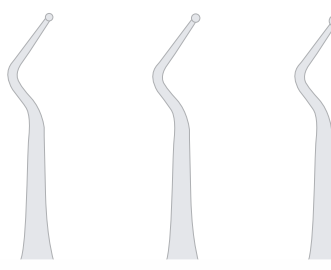

N° 17 N° 18 N° 19

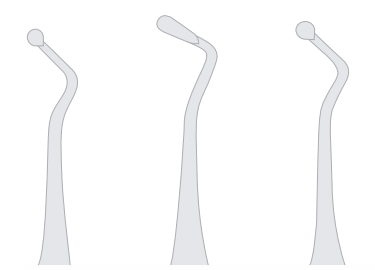

ø 4,5 mm

ø 5,5 mm

ø 4,5 mm

DARBY-PERRY

- 83.446.17 N° 17118
- 83.446.19 N° 19120
- 83.446.21 N° 21122

- 83.452.05 N° 1131114
- 83.452.06 N° 1151116
- 83.452.07 N° 1171118
- 83.452.08 N° 1191120
- 83.452.09 N° 1211122
- 83.452.10 N° 1231124
- 83.452.11 N° 1251126
- 83.452.12 N° 1271128
- 83.452.13 N° 1291130
- 83.452.14 N° 1311132
- 83.452.15 N° 1331134

- 83.462.41 N° 1411142
- 83.462.59 N° 1591160
- 83.462.61 N° 1611162
- 83.462.65 N° 1651166
- 83.462.71 N° 1711172
- 83.462.73 N° 1731174
- 83.462.75 N° 1751176

WHITE

- 83.481.05 N° 5
- 83.481.13 N° 13
- 83.481.14 N° 14
- 83.481.15 N° 15
- 83.481.17 N° 17
- 83.481.18 N° 18
- 83.481.19 N° 19

EXKAVATOREN, SCHMELZMEISSEL
 EXCAVATORS, ENAMEL CHISELS
 EXCAVATEURS, CISEAUX À ÉMAIL
 EXCAVADORES, CINCELES PARA ESMALTE
 ESCAVATORI, TAGLIASMALTI



N° 5 N° 13 N° 14



N° 26 N° 27 N° 28 N° 29



N° 17 N° 35

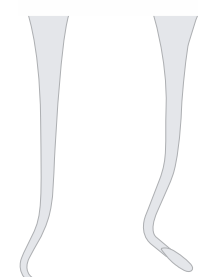

ø 6 mm

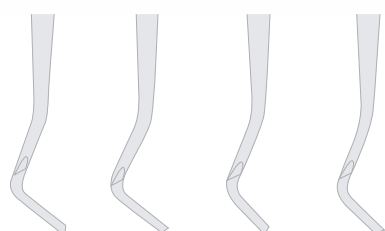

ø 6 mm

BLACK

- | | | |
|-----------|-------|---------------|
| 83.494.26 | N° 26 | hohler Griff |
| 83.494.27 | N° 27 | hollow handle |
| 83.494.28 | N° 28 | manche creux |
| 83.494.29 | N° 29 | mango hueco |
| | | manico cavo |

NERVKANALSTOPFER
 ROOT CANAL PLUGGERS
 OBTURATEURS DE CANAL
 OBTURADORES PARA CANALES
 OTTURATORI PER TRATTAMENTI CANALARI

0,40 mm 0,55 mm 0,75 mm

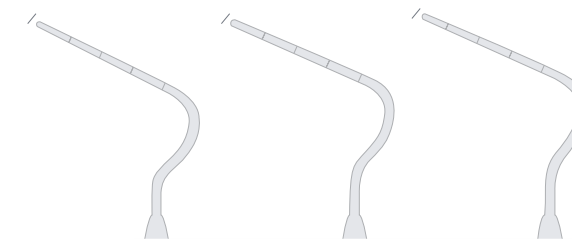

N° 8 N° 9 N° 10



1,05 mm 1,30 mm

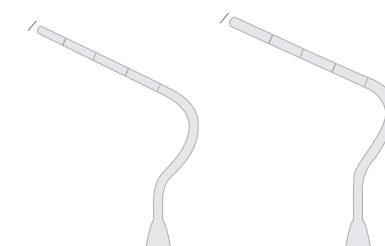

N° 11 N° 12

1/4

- | | |
|-----------|-------|
| 83.500.08 | N° 8 |
| 83.500.09 | N° 9 |
| 83.500.10 | N° 10 |
| 83.500.11 | N° 11 |
| 83.500.12 | N° 12 |



LUKS

83.501.01 N° L1

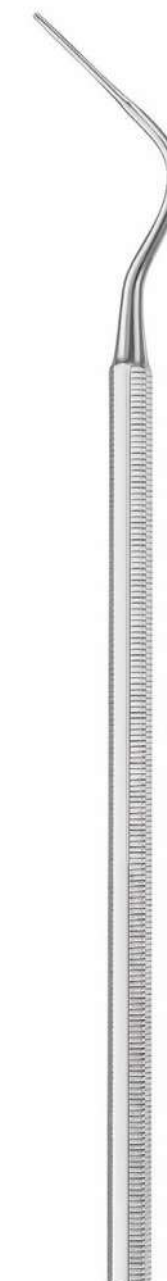

THUERRIEGEL

83.511.08

ø 5,5 mm

1/4

NERVKANALERWEITERER
 ROOT CANAL SPREADERS
 ÉLARGISSEURS DE CANAL
 EXTENDEDORES PARA CANALES
 ESTENSORI PER TRATTAMENTI CANALARI



1/1 83.502.25 N° 1S
 1/1 83.502.60 N° D11
 1/1 83.504.13 N° 113



Nervkanalzangen
 root canal forceps
 pinces pour canal
 pinza para canales
 pinze per canalari

1/1 83.525.13 13 cm/5"



1/1 83.524.13 13 cm/5"

17

- FÜLLUNGSINSTRUMENTE
 FILLING INSTRUMENTS
 INSTRUMENTS DE PLOMBAGE
 INSTRUMENTOS PARA OBTURACIONES
 OTTURATORI

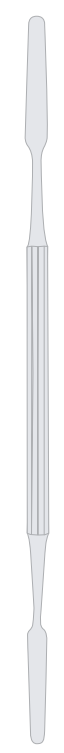

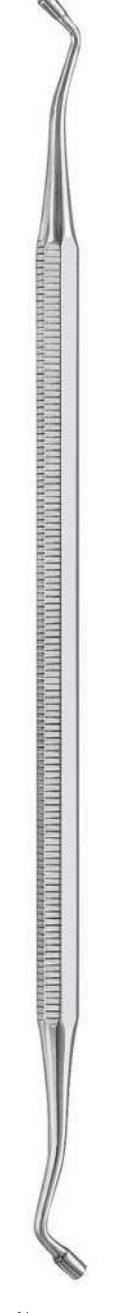
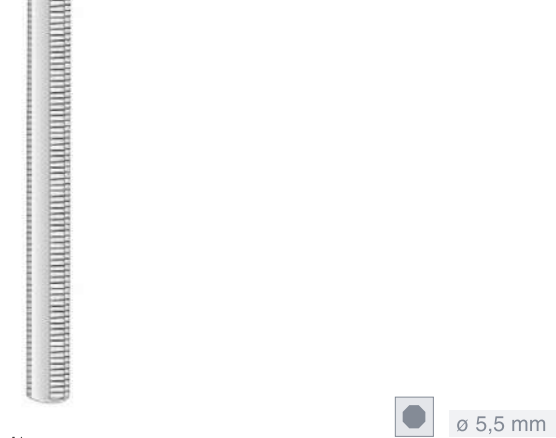
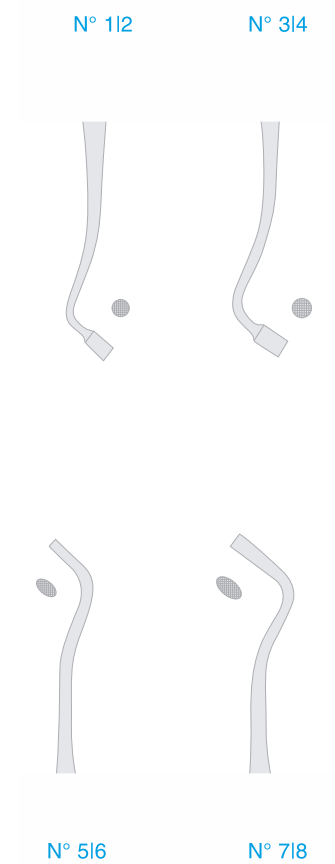
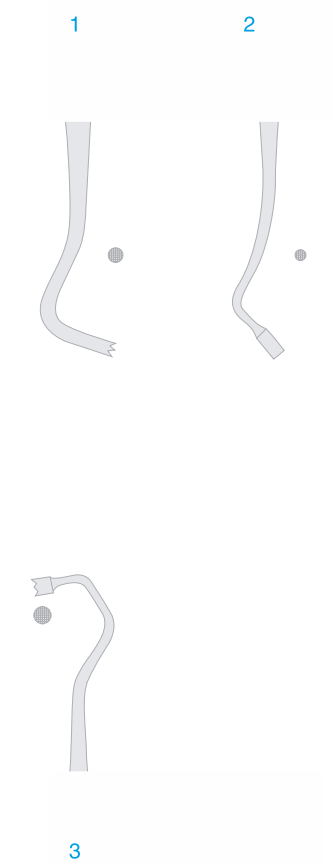
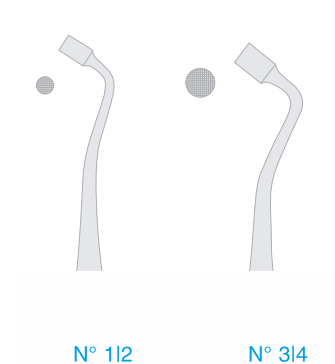
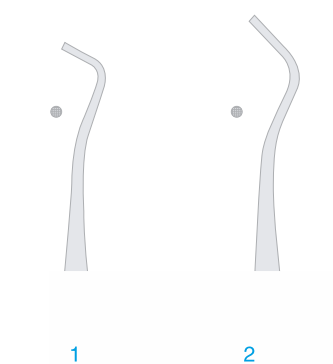
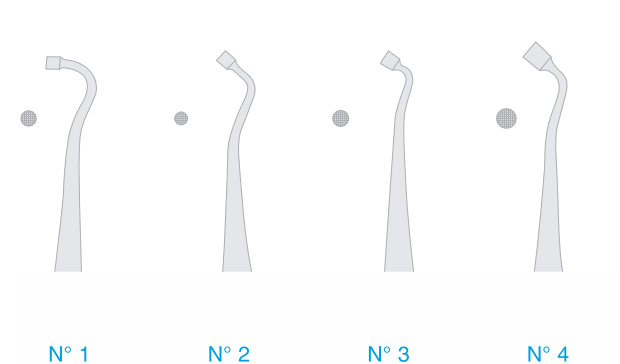
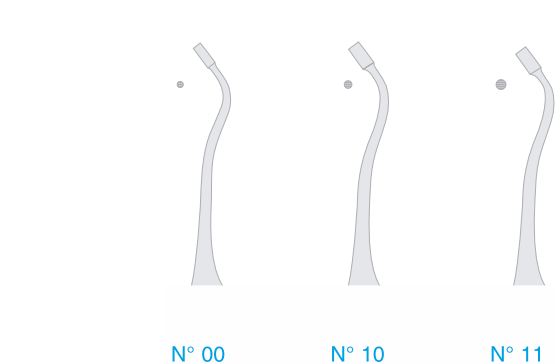

● ø 5,5 mm

● ø 5,5 mm

● ø 5,5 mm

● ø 5,5 mm

- BLACK**
- 84.141.00 N° 00
 - 84.141.10 N° 10
 - 84.141.11 N° 11
 - 84.141.12 N° 12
 - 84.141.13 N° 13

- 84.151.10 N° 1
- 84.151.20 N° 2
- 84.151.30 N° 3
- 84.151.40 N° 4
- 84.151.50 N° 5
- 84.151.51 N° 5A
- 84.151.60 N° 6
- 84.151.70 N° 7

- 84.163.00 ELLIOT 1
- 84.165.00 EAMES 2
- 84.167.00 HOLLENBACK 3

- HAUBEIL**
- 84.171.12 N° 112
 - 84.171.34 N° 314
 - 84.171.56 N° 516
 - 84.171.78 N° 718

84.152.07

1,0 mm

1,6 mm

AMALGAMSTOPFER
 AMALGAM PLUGGER
 FOULOIRS À AMALGAME
 OBTURADORES PARA AMALGAMA
 OTTURATORI PER AMALGAMA

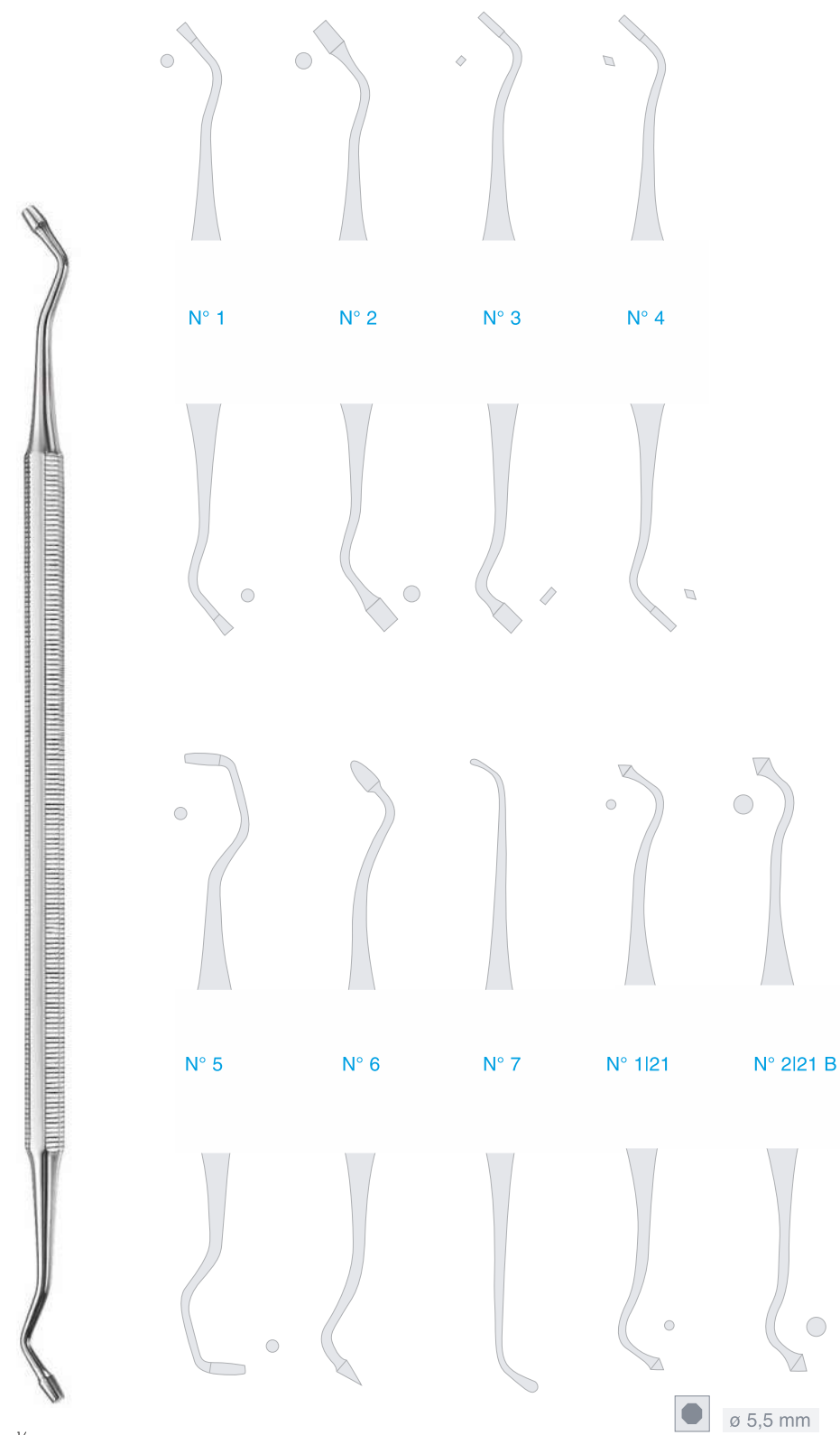

1/1
HOLLENBACK **WESTCOTT**

- | | | | |
|-----------|------|-----------|-----------|
| 84.175.01 | N° 1 | 84.177.01 | N° 1I21 |
| 84.175.02 | N° 2 | 84.177.02 | N° 2I21 B |
| 84.175.03 | N° 3 | | |
| 84.175.04 | N° 4 | | |
| 84.175.05 | N° 5 | | |
| 84.175.06 | N° 6 | | |
| 84.175.07 | N° 7 | | |

Plomben- und Verschlussheber
 instrument for lifting and loosening temporary fillings
 instrument pour enlever les plombages temporaires
 instrumentos para quitar obturaciones temporales
 strumenti per estrazione di otturazioni provvisorie



1/1
 84.358.00

AMALGAMINSTRUMENTE
 AMALGAM INSTRUMENTS
 INSTRUMENTES POUR AMALGAME
 INSTRUMENTOS PARA AMALGAMA
 STRUMENTI PER AMALGAMA

Amalgampistolen
 amalgam carriers
 porte-amalgames
 porta-amalgamas
 pistole per amalgama

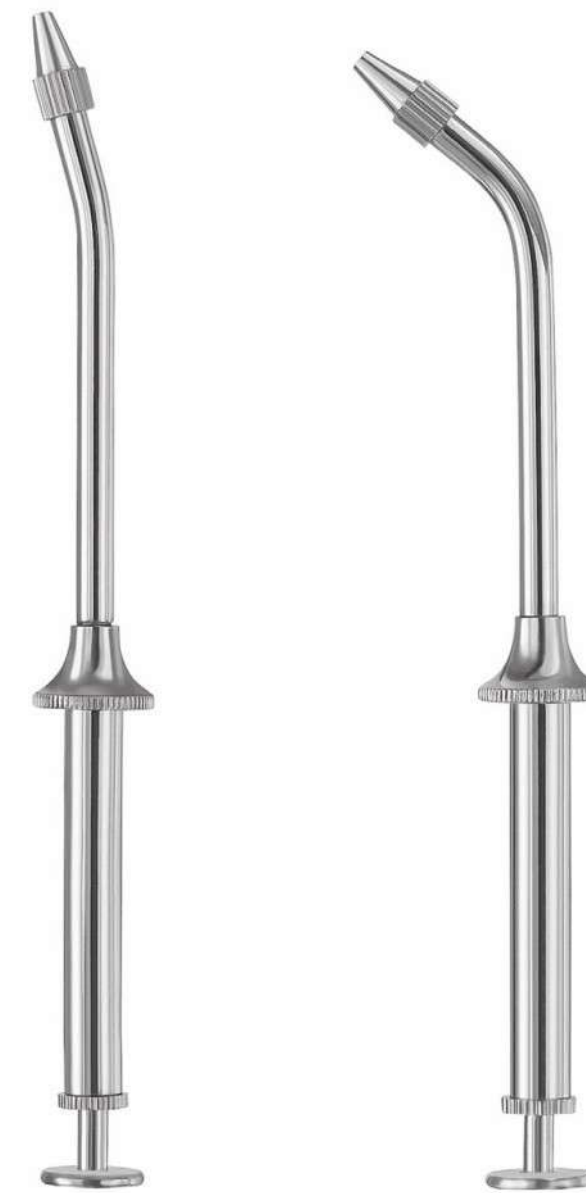

1/1
 84.185.01

Plastikspitze
 plastic tip
 pointe en plastique
 punta de plástico
 punta in plastica



84.185.02

Metallspitze
 metal tip
 pointe en métal
 punta de metal
 punta in metallo



1/1
 84.187.01



84.187.02



Amalgamträger
 amalgam carriers
 porte-amalgames
 porta-amalgamas
 pistole per amalgama



1/2
IVORY
 84.206.17
 17 cm 6 3/4"

1/2
IVORY
 84.206.21
 21 cm 8 1/4"

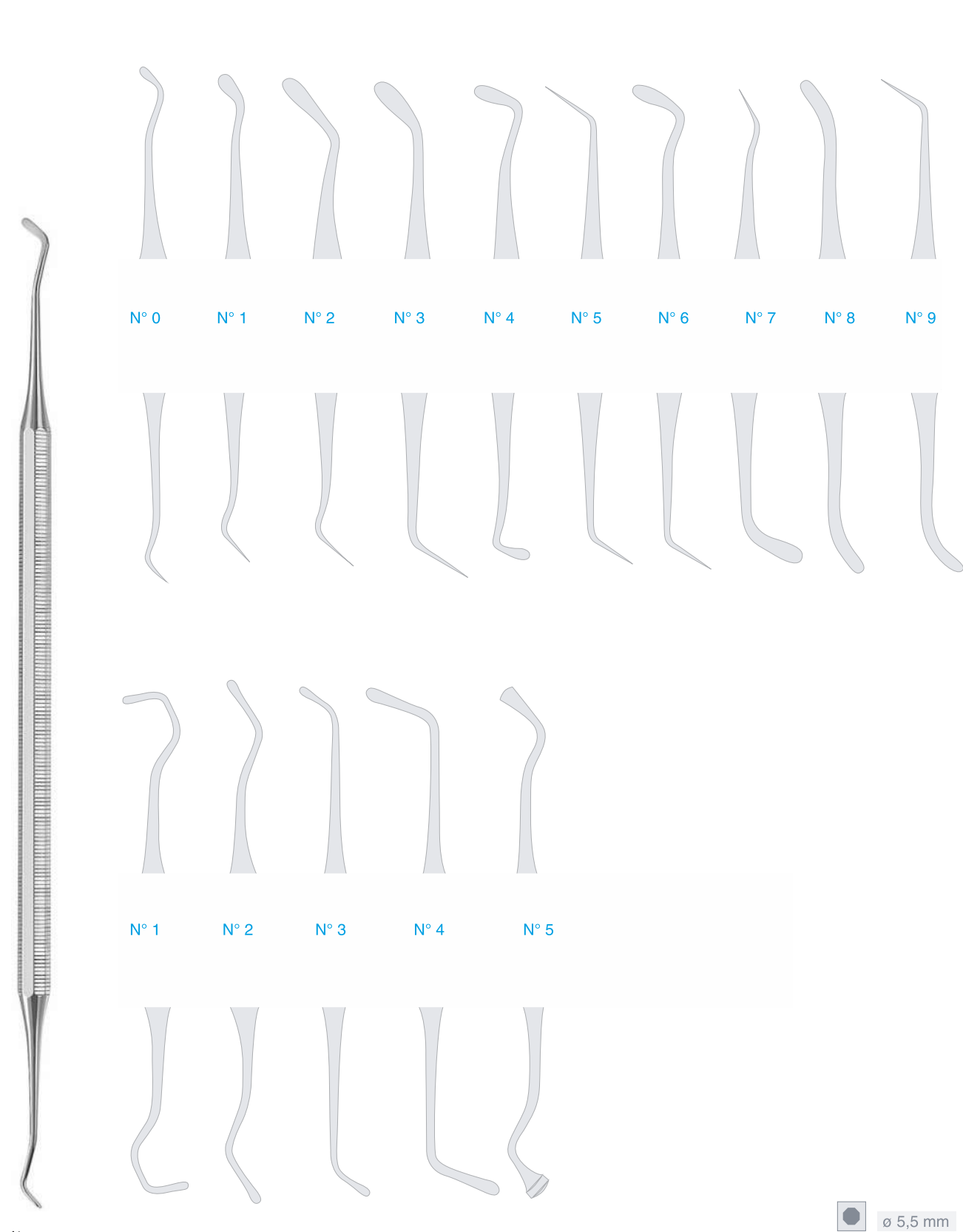
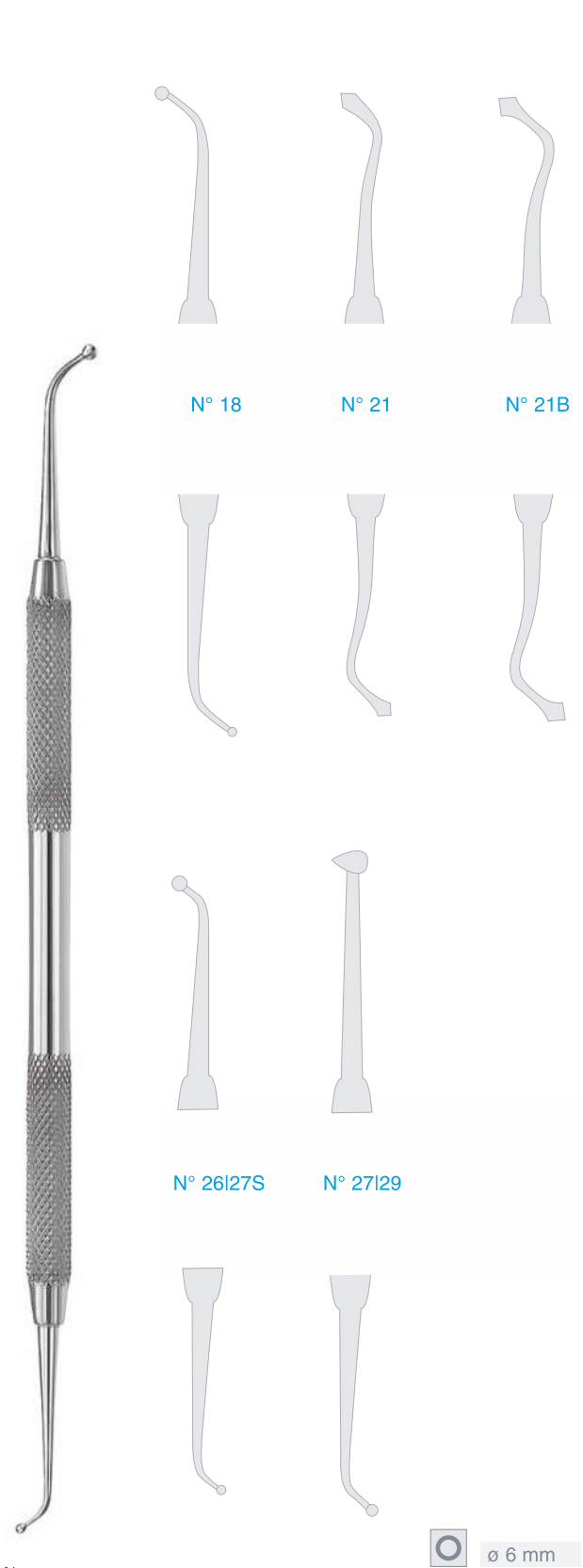
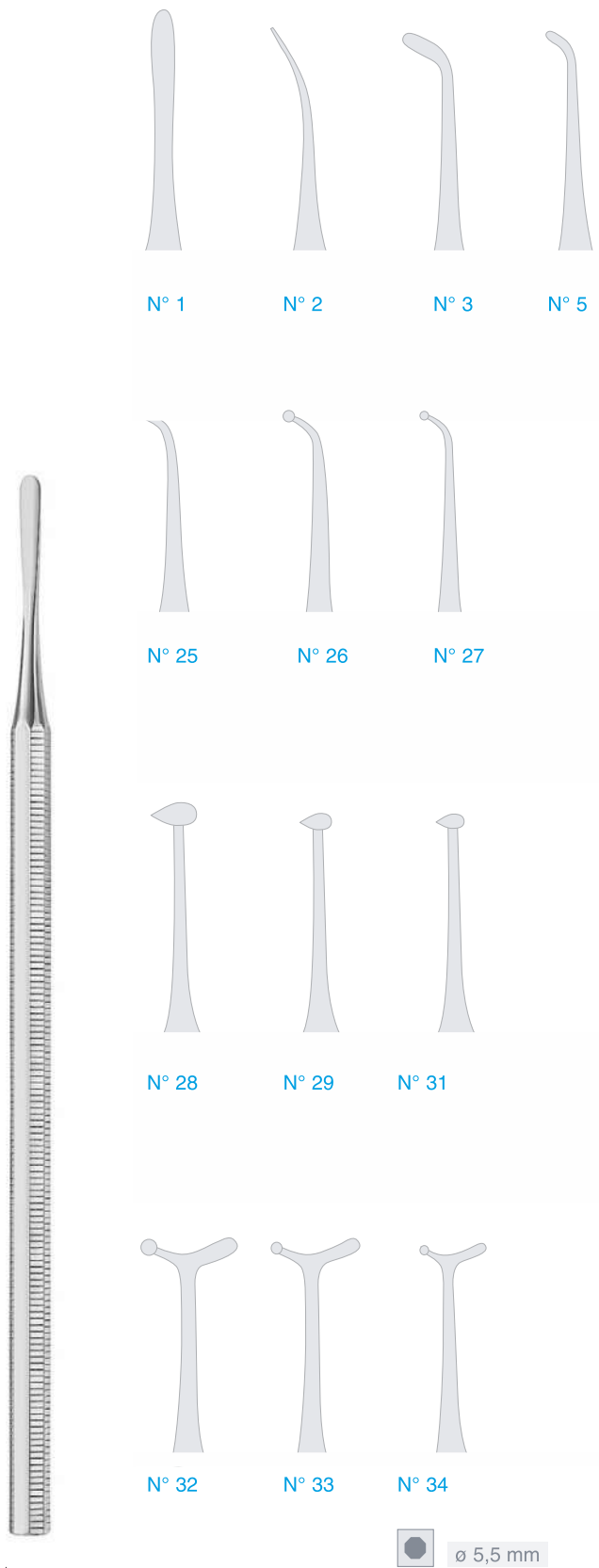

N° 1 N° 2 N° 3 N° 5



N° 25 N° 26 N° 27

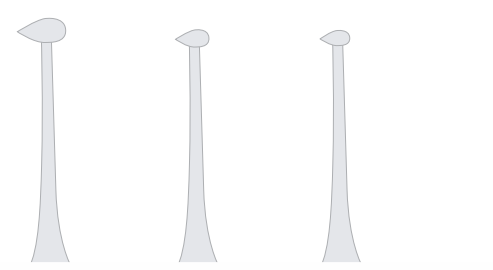

N° 28 N° 29 N° 31

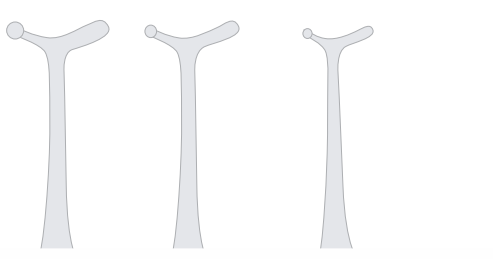

N° 32 N° 33 N° 34

● ø 5,5 mm

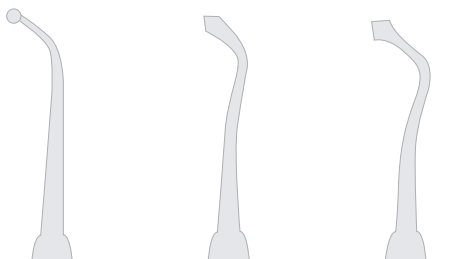

N° 18 N° 21 N° 21B



N° 26I27S N° 27I29

○ ø 6 mm



N° 0 N° 1 N° 2 N° 3 N° 4 N° 5 N° 6 N° 7 N° 8 N° 9



N° 1 N° 2 N° 3 N° 4 N° 5

● ø 5,5 mm

WHITE

84.231.01	N° 1	84.231.26	N° 26
84.231.02	N° 2	84.231.27	N° 27
84.231.03	N° 3	84.231.28	N° 28
84.231.05	N° 5	84.231.29	N° 29
84.231.25	N° 25	84.231.31	N° 31
		84.231.32	N° 32
		84.231.33	N° 33
		84.231.34	N° 34

84.233.18	BALL	N° 18
84.233.21	ACORN	N° 21
84.233.22	ACORN	N° 21B
84.233.26	BALL	N° 26I27S
84.233.27	BALL	N° 27I29

84.251.00	N° 0
84.251.01	N° 1
84.251.02	N° 2
84.251.03	N° 3
84.251.04	N° 4
84.251.05	N° 5
84.251.06	N° 6

84.251.07	N° 7
84.251.08	N° 8
84.251.09	N° 9

LADMORE

84.261.01	N° 1
84.261.02	N° 2
84.261.03	N° 3
84.261.04	N° 4
84.261.05	N° 5

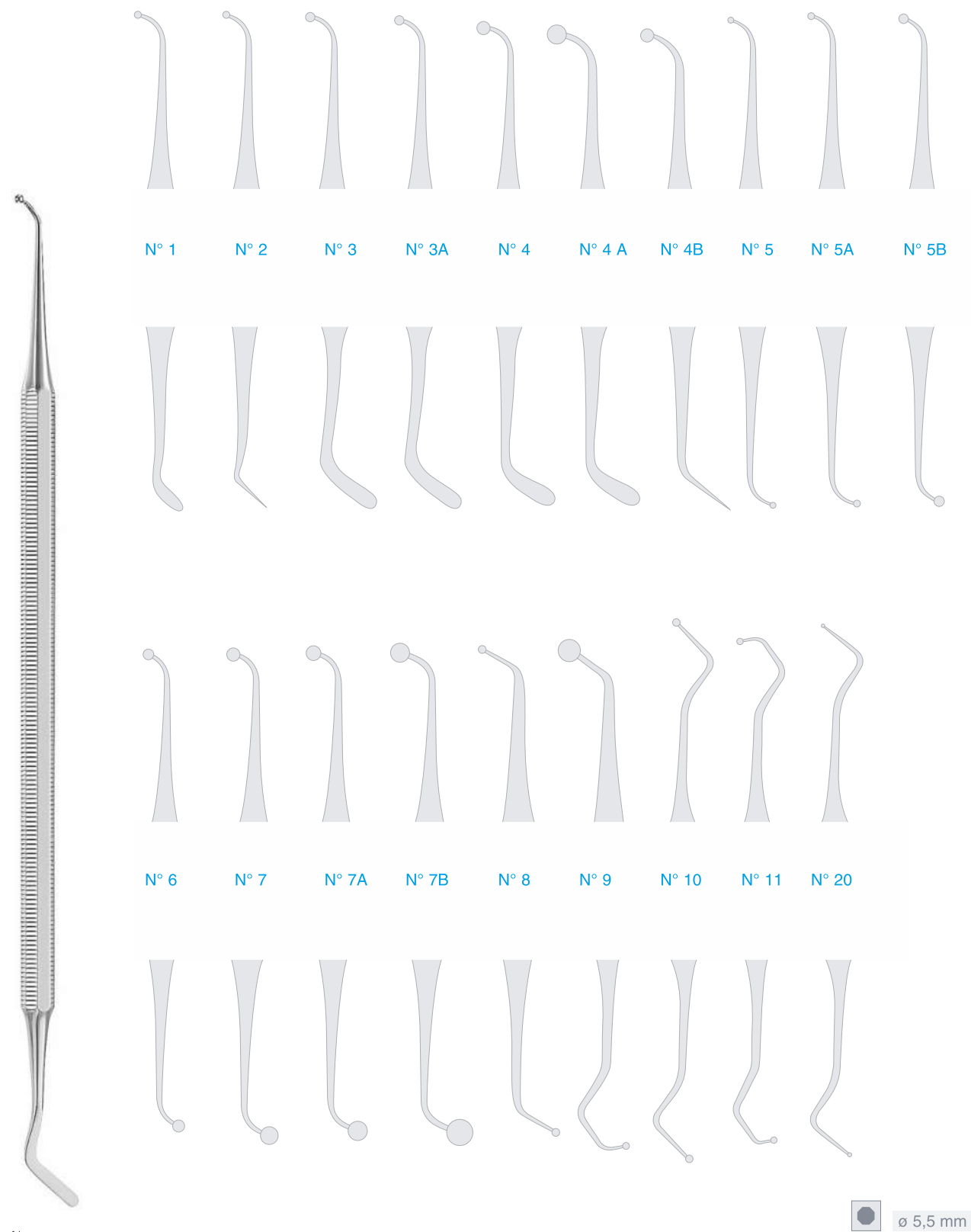

N° 1 N° 2 N° 3 N° 3A N° 4 N° 4 A N° 4B N° 5 N° 5A N° 5B

N° 6 N° 7 N° 7A N° 7B N° 8 N° 9 N° 10 N° 11 N° 20

● ø 5,5 mm

84.270.10	N° 1	84.270.50	N° 5	84.270.80	N° 8
84.270.20	N° 2	84.270.51	N° 5A	84.270.90	N° 9
84.270.30	N° 3	84.270.52	N° 5B	84.271.10	N° 10
84.270.31	N° 3A	84.270.60	N° 6	84.271.11	N° 11
84.270.40	N° 4	84.270.70	N° 7	84.271.20	N° 20 DYCAL
84.270.41	N° 4A	84.270.71	N° 7A		
84.270.42	N° 4B	84.270.72	N° 7B		



HEIDEMANN N° 0 N° 1 N° 2 MOESLE N° 1 N° 2 SMITH N° 1 BALDWIN N° 49

WOODSON N° 1 N° 2 N° 3 WILLIAMS N° 0 N° 1 N° 2 LINSEMAN N° 3

● ø 5,5 mm

HEIDEMANN		MOESLE		BALDWIN		WILLIAMS	
84.277.00	N° 0	84.278.01	N° 1	84.283.49	N° 49	84.321.00	N° 0
84.277.01	N° 1	84.278.02	N° 2			84.321.01	N° 1
84.277.02	N° 2			WOODSON		84.321.02	N° 2
		SMITH		84.311.01	N° 1	LINSEMAN	
		84.282.01	N° 1	84.311.02	N° 2	84.341.03	N° 3
				84.311.03	N° 3		

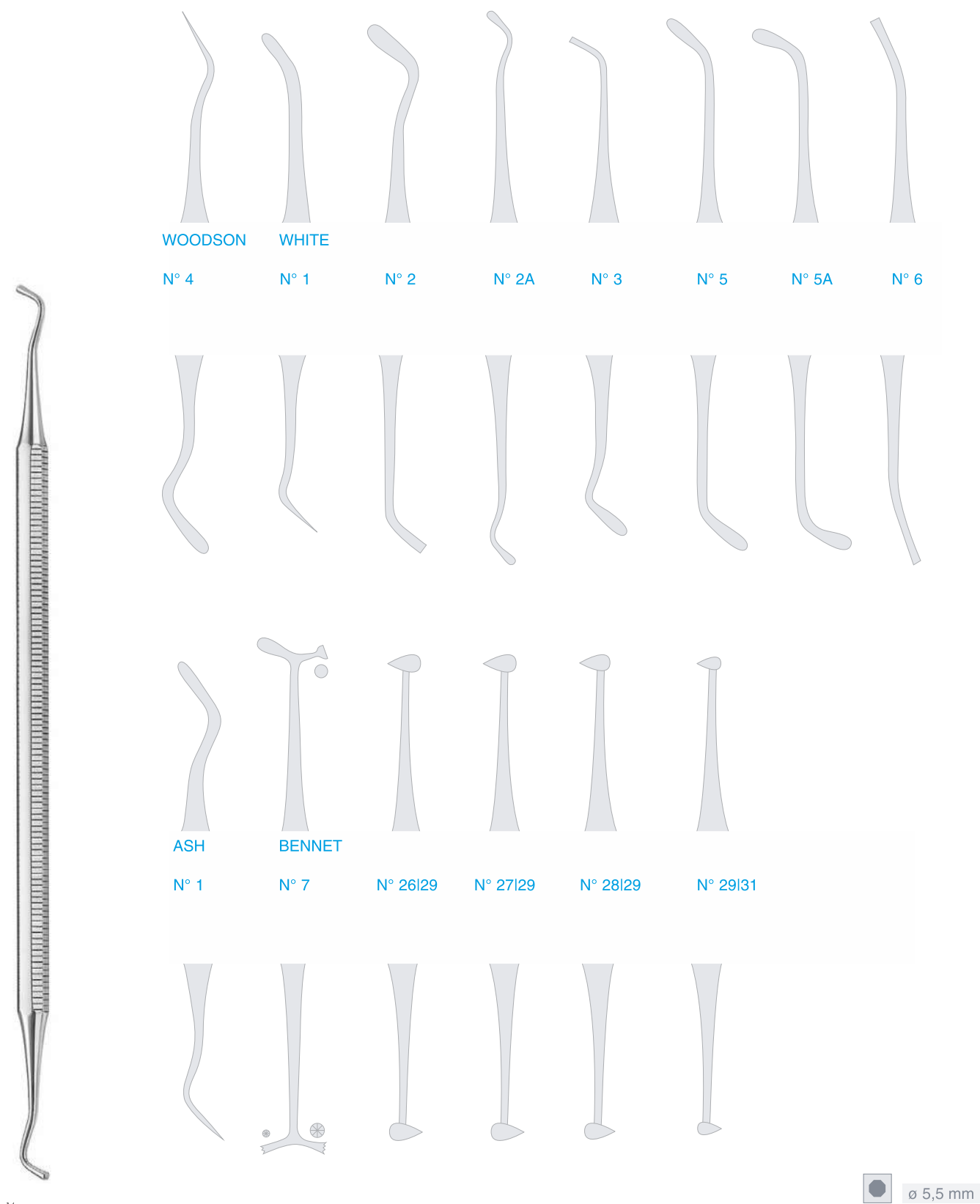

WOODSON	WHITE	ASH	BENNET
84.301.04 N° 4	84.305.10 N° 1 84.305.20 N° 2 84.305.21 N° 2A 84.305.30 N° 3 84.305.50 N° 5 84.305.51 N° 5A 84.305.60 N° 6	84.342.06 N° 1	84.349.07 N° 7 84.357.26 N° 26 29 84.357.27 N° 27 29 84.357.28 N° 28 29 84.357.29 N° 29 31



84.361.01 N° 1	84.361.09 N° 9
84.361.02 N° 2	84.361.10 N° 10
84.361.03 N° 3	84.361.11 N° 11
84.361.04 N° 4	84.361.12 N° 12
84.361.05 N° 5	84.361.13 N° 13
84.361.06 N° 6	84.361.14 N° 14
84.361.07 N° 7	84.361.15 N° 15
84.361.08 N° 8	84.361.16 N° 16

INSTRUMENTE FÜR PLASTISCHE FÜLLUNGEN
 PLASTIC FILLING INSTRUMENTS
 INSTRUMENTS POUR PLOMBAGES PLASTIQUES
 INSTRUMENTOS PARA OBTURACIONES PLÁSTICAS
 STRUMENTI PER OTTURAZIONE PLASTICHE

ZEMENTSPATEL
 CEMENT SPATULAS
 SPATULES À CIMENT
 ESPÁTULAS PARA CEMENTO
 SPATOLE PER CEMENTO



84.361.17	N° 17	84.361.25	N° 25	84.361.33	N° 33
84.361.18	N° 18	84.361.26	N° 26	84.361.34	N° 34
84.361.19	N° 19	84.361.27	N° 27	84.361.35	N° 35
84.361.20	N° 20	84.361.28	N° 28	84.361.36	N° 36
84.361.21	N° 21	84.361.29	N° 29	84.361.37	N° 37
84.361.22	N° 22	84.361.30	N° 30		
84.361.23	N° 23	84.361.31	N° 31		
84.361.24	N° 24	84.361.32	N° 32		

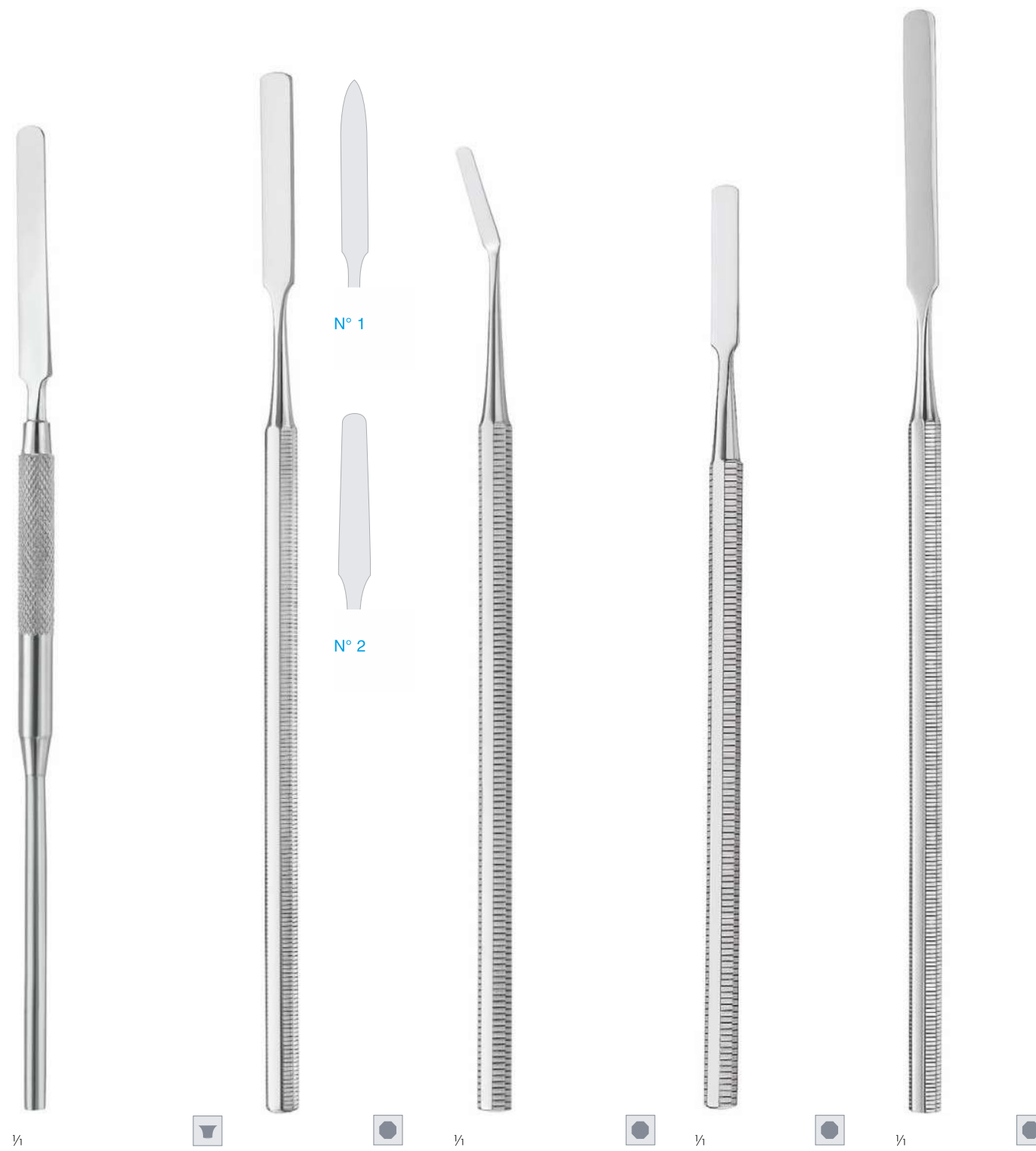

84.411.24	44 mm	N° 24	84.410.06	N° 6	84.408.02	N° 2	84.412.03	N° 3	84.412.04	N° 4
84.411.06	25 mm	N° A6	84.412.01	N° 1						
			84.412.02	N° 2						

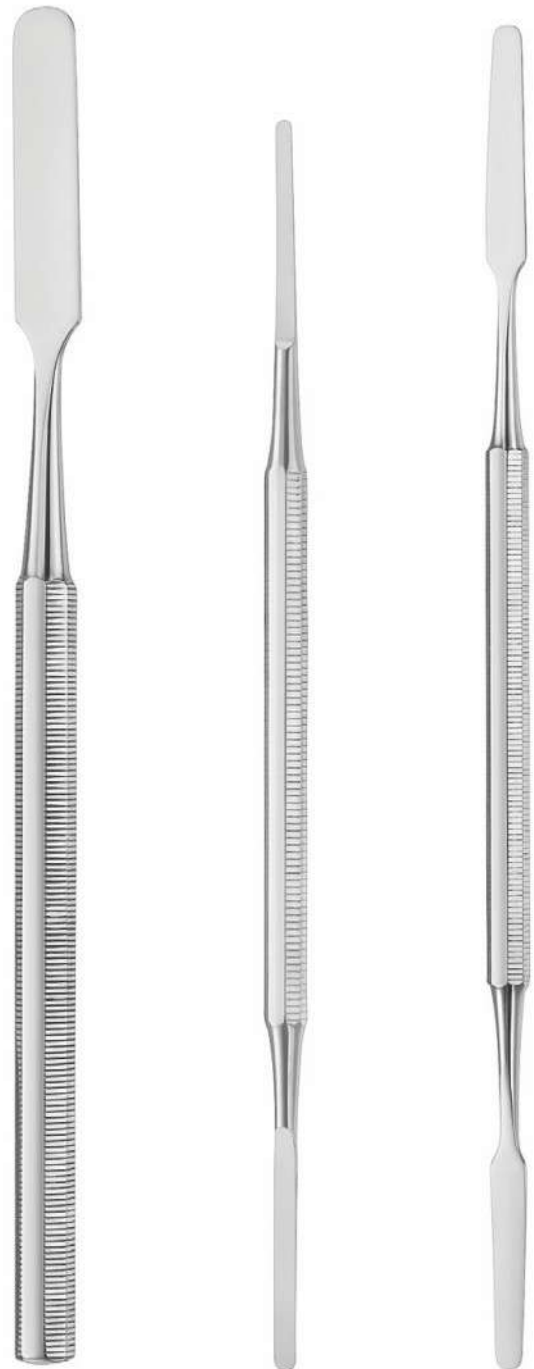

1/4 ø 5,5 mm 1/4

- | | | | | |
|-----------------|----------------|----------------|----------------|----------------|
| 84.420.36 N° 36 | 84.426.01 N° 1 | 84.431.01 N° 1 | 84.436.01 N° 1 | 84.436.04 N° 4 |
| | | 84.431.02 N° 2 | 84.436.02 N° 2 | 84.436.05 N° 5 |
| | | 84.431.03 N° 3 | 84.436.03 N° 3 | 84.436.06 N° 6 |

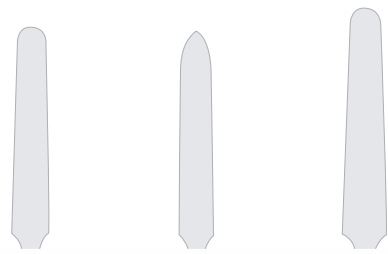

N° 1 N° 2 N° 3

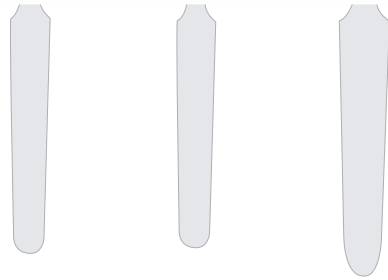

N° 1 N° 2 N° 3



N° 1 N° 2 N° 3



84.404.10 9,5 x 7 cm

Anrührplatte aus Glas
mixing tablet, glass
plaque en verre à gâcher
placa de vidrio para mezclar
piastrella di vetro per mescolare

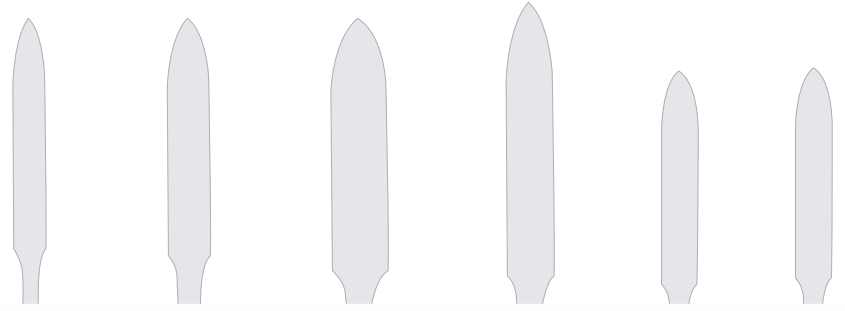

N° 1 N° 2 N° 3 N° 4 N° 5 N° 6

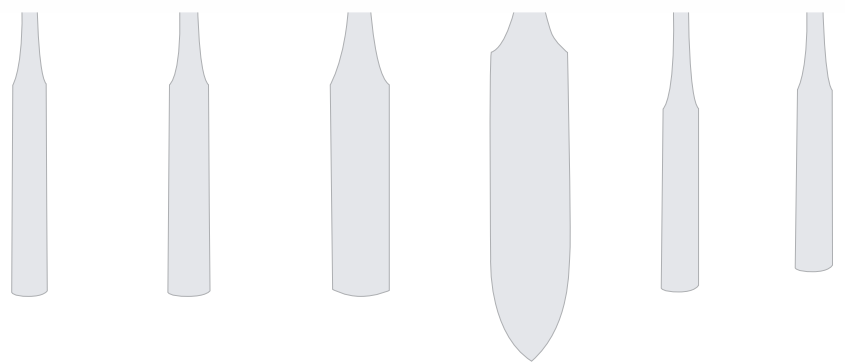

N° 1 N° 2 N° 3 N° 4 N° 5 N° 6

ø 5,5 mm



1/2
IVORY
84.465.01 N° 1



1/2
IVORY
84.467.01 N° 12



1/2
IVORY
84.468.01 N° 12A



1/2
IVORY
84.460.01 N° 14



DIDNER
84.483.05 N° 8P



IVORY
84.481.05 N° 8 N



IVORY
84.480.05 5 mm N° 8
84.480.06 6 mm N° 8
84.480.07 7 mm N° 8



TOFFLEMIRE
84.477.01



NYSTROEM
84.474.00



N° 1



N° 2



N° 3



N° 4



N° 5



N° 6

84.470.01 N° 1

84.470.02 N° 2

84.470.03 N° 3

84.470.04 N° 4

84.470.05 N° 5

84.470.06 N° 6

12 Stück
12 pieces
12 pièces
12 piezas
12 pezzi



N° 1



N° 2



N° 3



N° 13

TOFFLEMIRE

84.482.01 N° 1 12 Stück
84.482.02 N° 2 12 pieces
84.482.03 N° 3 12 pièces
84.482.13 N° 13 12 piezas
12 pezzi



84.485.05 5 mm
84.485.06 6 mm
84.485.07 7 mm



½

AINSWORTH

84.500.16 16 cm 6¼"



½

IVORY

84.502.15 15 cm 6"

Kofferdam-Lochzangen
rubberdam punch forceps
pinces perforatrices
perforadores para dique de goma
pinze per forare la diga di gomma



½

PALMER

84.505.17 17 cm 6¾"



½

IVORY

84.506.16 16 cm 6¼"



½

BREWER

84.513.17 17 cm 6¾"

Kofferdam-Klammerzange
rubberdam clamp forceps
pinces à digue
pinzas de grapa para dique de goma
pinze per uncini



N° 26 N° 28 N° 30

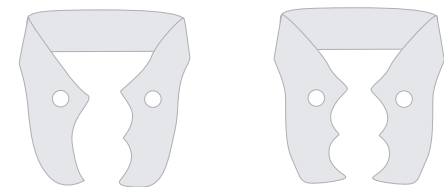

N° 31 N° 51



N° 27 N° 29 N° 60

IVORY

84.515.26	N° 26	84.515.30	N° 30
84.515.27	N° 27	84.515.31	N° 31
84.515.28	N° 28	84.515.51	N° 51
84.515.29	N° 29	84.515.60	N° 60

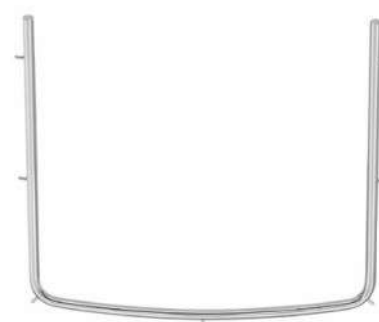

84.514.00 110 x 95 mm

Kofferdam-Rahmen
 rubberdam frame
 cadre à digue
 cuadro para dique de goma
 cornice per diga di gomma

18

- PROTHETIK
- PROSTHETICS
- PROTHÈSES
- PRÓTESIS
- PROTESI

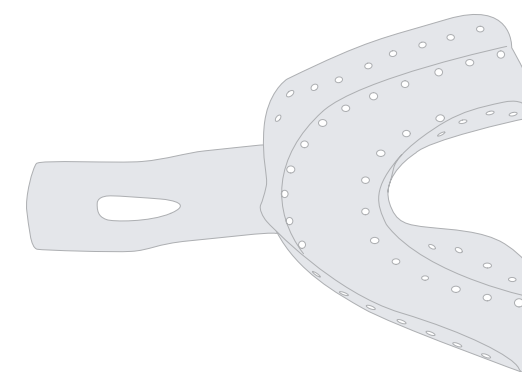



rostfrei 18|10
stainless steel 18|10
acier inoxydable 18|10
acero inoxidable 18|10
acciaio inossidabile 18|10



86.101.00	59 x 42 mm	BO 0
86.101.01	66 x 52 mm	BO 1
86.101.02	71 x 62 mm	BO 2
86.101.03	71 x 64 mm	BO 3
86.101.04	80 x 70 mm	BO 4

rostfrei 18|10
stainless steel 18|10
acier inoxydable 18|10
acero inoxidable 18|10
acciaio inossidabile 18|10



86.103.01	61 x 51 mm	FO 1
86.103.02	68 x 54 mm	FO 2
86.103.03	77 x 65 mm	FO 3

rostfrei 18|10
stainless steel 18|10
acier inoxydable 18|10
acero inoxidable 18|10
acciaio inossidabile 18|10



86.108.01	70 x 48 mm	UU 1
86.108.02	70 x 53 mm	UU 2
86.108.03	72 x 57 mm	UU 3
86.108.04	70 x 58 mm	UU 4

mit drehbarem Griff
with swivel handle
avec manche pivotant
con mango giratorio



86.175.01



86.176.11

rostfrei 18|10
stainless steel 18|10
acier inoxydable 18|10
acero inoxidable 18|10
acciaio inossidabile 18|10



86.102.01	62 x 50 mm	PO 1
86.102.02	70 x 56 mm	PO 2
86.102.03	72 x 52 mm	PO 3

rostfrei 18|10
stainless steel 18|10
acier inoxydable 18|10
acero inoxidable 18|10
acciaio inossidabile 18|10



86.106.00	65 x 46 mm	BU 0
86.106.01	67 x 50 mm	BU 1
86.106.02	76 x 54 mm	BU 2
86.106.03	79 x 56 mm	BU 3
86.106.04	79 x 61 mm	BU 4

rostfrei 18|10
stainless steel 18|10
acier inoxydable 18|10
acero inoxidable 18|10
acciaio inossidabile 18|10



86.161.01	44 mm	N° 1
86.161.02	55 mm	N° 2
86.161.03	60 mm	N° 3
86.161.04	65 mm	N° 4

rostfrei 18|10
stainless steel 18|10
acier inoxydable 18|10
acero inoxidable 18|10
acciaio inossidabile 18|10



86.151.01	44 mm	N° 1
86.151.02	55 mm	N° 2
86.151.03	60 mm	N° 3
86.151.04	65 mm	N° 4



86.320.13

Weichgummi
 soft rubber
 caoutchouc mou
 goma blanda
 gomma morbida



1/4

SCHWARZ

86.280.17 16,5 cm|6 1/2"



1/4

LICHTENSTEIN

86.288.17 17 cm|6 3/4"



FAHNENSTOCK

86.482.13 13 cm|5"
 86.482.17 17 cm|6 3/4"



LESSMANN

86.484.13 13 cm|5"
 86.484.17 17 cm|6 3/4"



86.483.17 17 cm|6 3/4"



GISY-WILD

86.480.15 15 cm|6"



ANTKOVIK

86.486.12 12,5 cm|5"



86.488.00

14 cm|5 1/2"



86.490.00

13,5 cm|5 1/4"



GRITMAN

86.290.16 16 cm|6 1/4"



Artikulationspapierpinzetten
articulating paper forceps
pinces pour papier d'articulation
pinzas para papel de articulación
pinze per carta di articolazione



1/1

BAUSCH

86.514.16 15,5 cm16"



1/1

MILLER

86.517.15 15,5 cm16"



1/1

BAUSCH

86.519.00 16 cm16 1/4"

Kronensetzer aus Plexiglas
crown setter made of plexiglass
ajusteur de couronnes en plexiglas
fijador de coronas de plexiglás
fissatore de corona di plexiglas



SACHS

86.520.01

Bandtreiber
band pusher
ajusteur de bande
ajustador de bandas
regolatore di bande



MERSHON

86.528.01



SCHURE

86.530.00



87.757.18 18 cm17"



Kronensetzer
crown setter
ajusteur de couronnes
fijador de coronas
fissatore de corona



86.532.01 14,5 cm15 3/4"

Kronenabnehmer
crown remover
extracteur de couronnes
extractor de coronas
estrattore per corona



MILLER

86.580.01

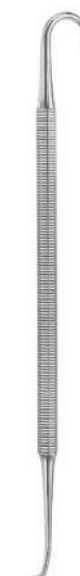

TREYMAN

86.578.01



1/1

BOEHM

87.703.12 12 cm14 3/4"
87.703.15 15 cm16"



1/1

87.760.14 14,5 cm15 3/4"



TRYFUS

87.740.16 16 cm 6 1/4"

Dentimeter
dentimeter
dentimètre
dentímetro
dentimetro



HOW

87.750.14 14 cm 5 1/2"

Kronenaufschneidezange
crown splitter
pince à fendre les couronnes
pinza para cortar coronas
pinza per tagliati corone



HOW

87.751.14 14 cm 5 1/2"



MOD.PARIS

86.546.01 16 cm 6 1/4"



MONFORT

86.590.19 19 cm 7 1/2"



87.754.00 14 cm 5 1/2"

87.754.12 Gummipolster (Paar)
rubber inserts (pair)
rembourrage en caoutchouc (paire)
bocas de goma (par)
cuscino di gomma (paio)

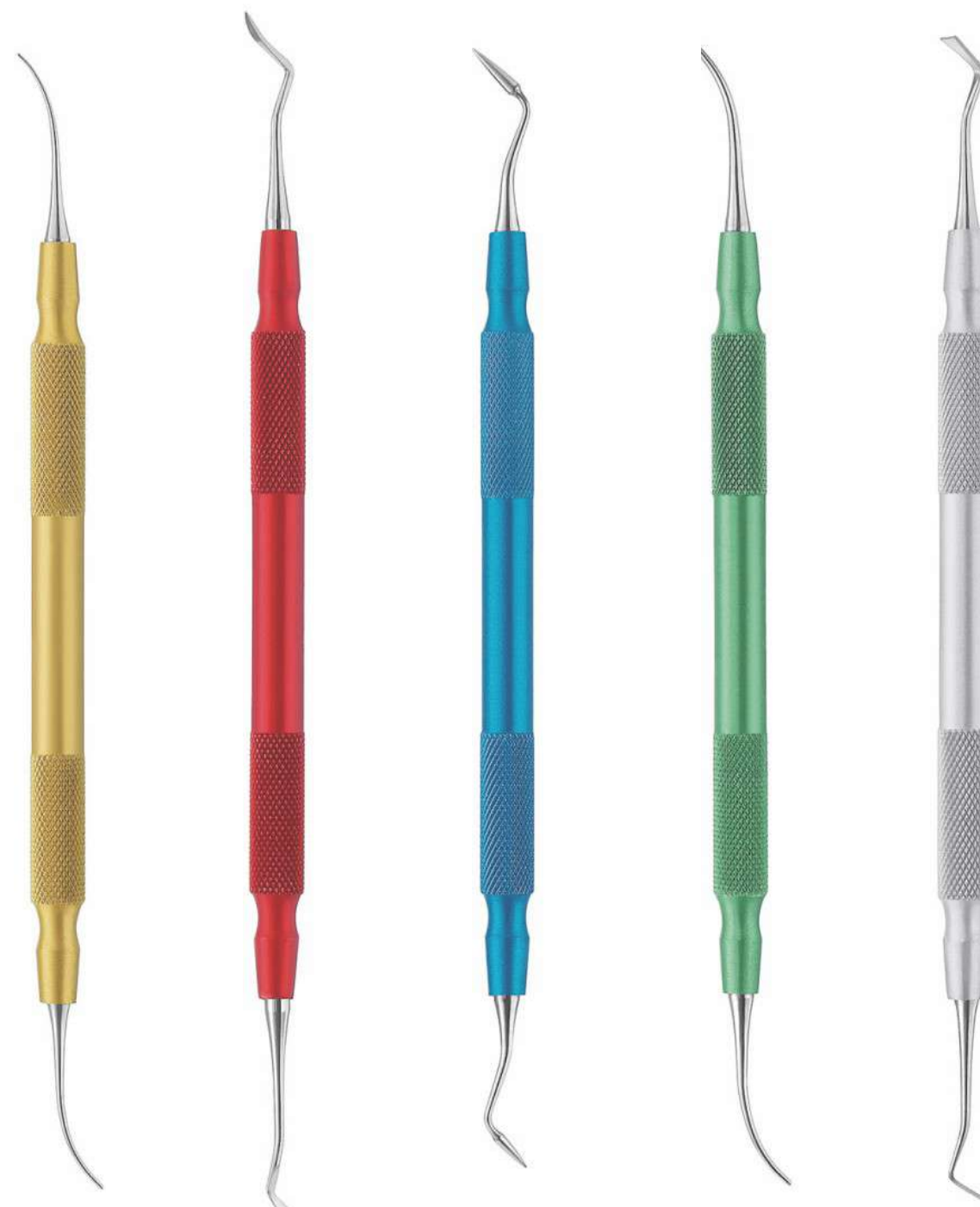

1/2

P. K. THOMAS

86.360.11 N° 1

1/2

P. K. THOMAS

86.360.12 N° 2

1/2

P. K. THOMAS

86.360.13 N° 3

1/2

P. K. THOMAS

86.360.14 N° 4

1/2

P. K. THOMAS

86.360.15 N° 5

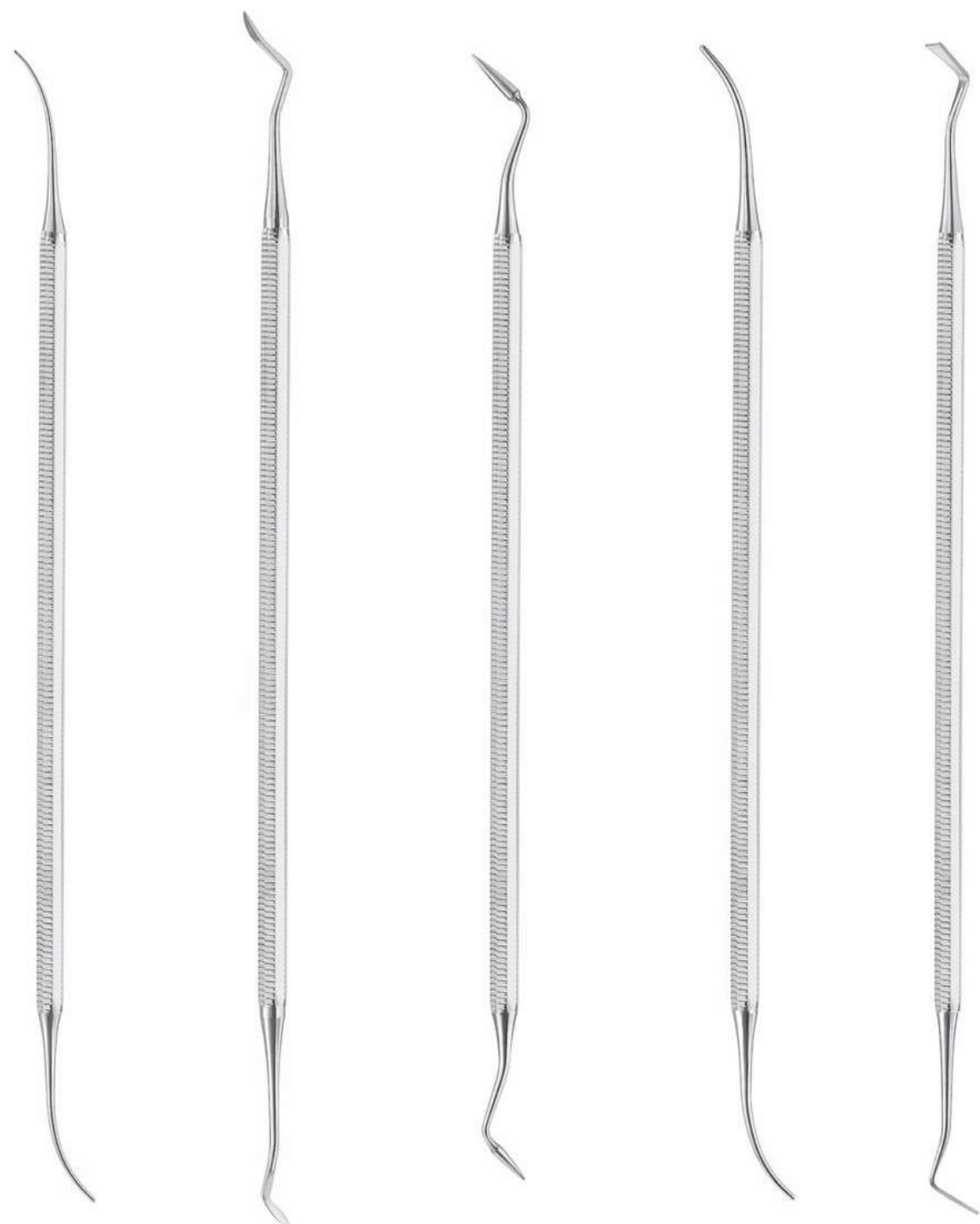

$\frac{1}{2}$	$\frac{1}{2}$	$\frac{1}{2}$	$\frac{1}{2}$	$\frac{1}{2}$
P. K. THOMAS	P. K. THOMAS	P. K. THOMAS	P. K. THOMAS	P. K. THOMAS
86.360.01 N° 1	86.360.02 N° 2	86.360.03 N° 3	86.360.04 N° 4	86.360.05 N° 5

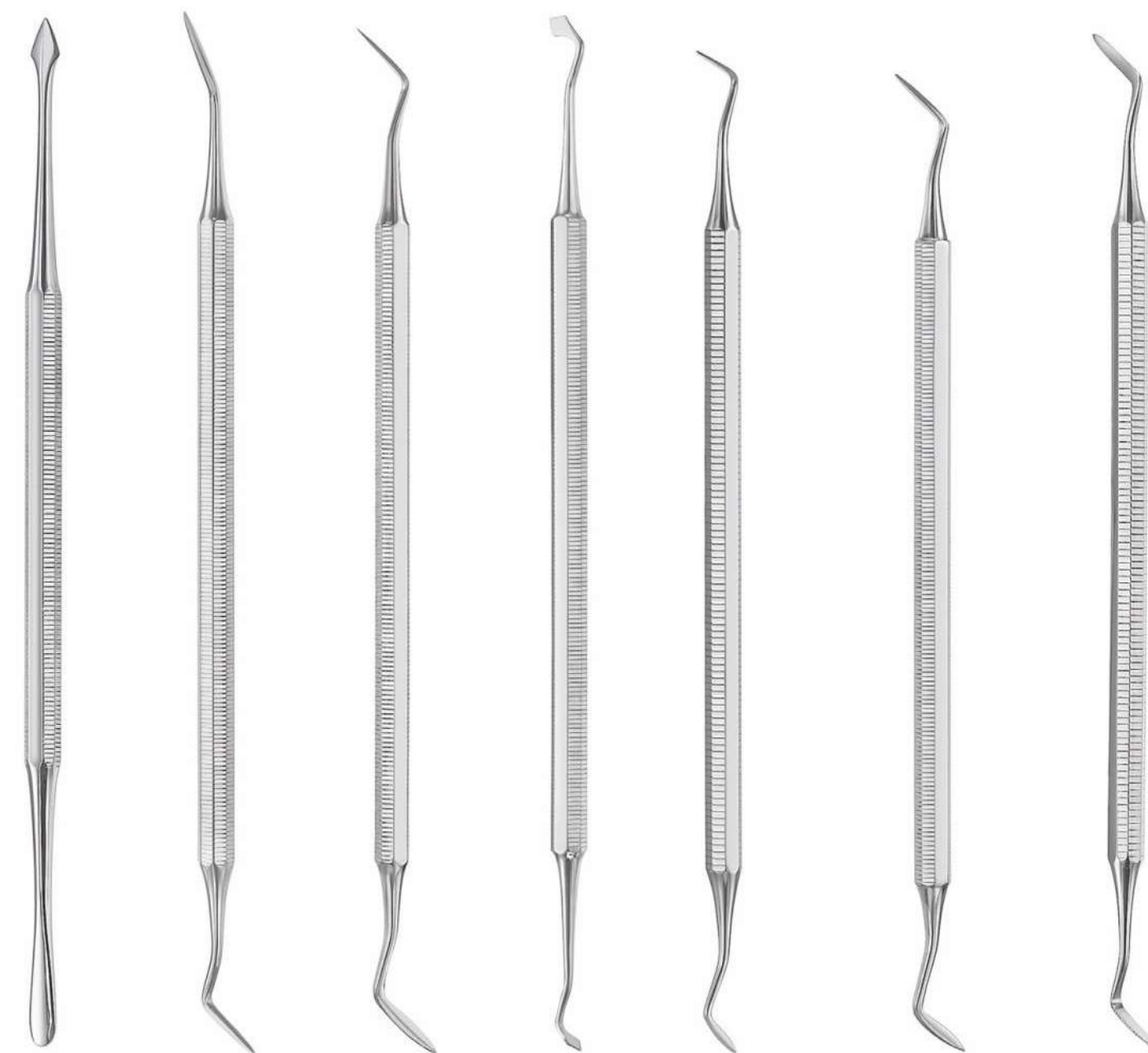

$\frac{1}{2}$	$\frac{1}{2}$	$\frac{1}{2}$	$\frac{1}{2}$	$\frac{1}{2}$	$\frac{1}{2}$	$\frac{1}{2}$
GRITMAN	WARD	WARD	FRAHM	HOLLENBACK	HOLLENBACK	WAERHAUG
86.350.01	86.354.01 N° 1	86.354.02 N° 2	86.356.01	86.370.31 N° 3S	86.370.30 N° 3	86.366.00

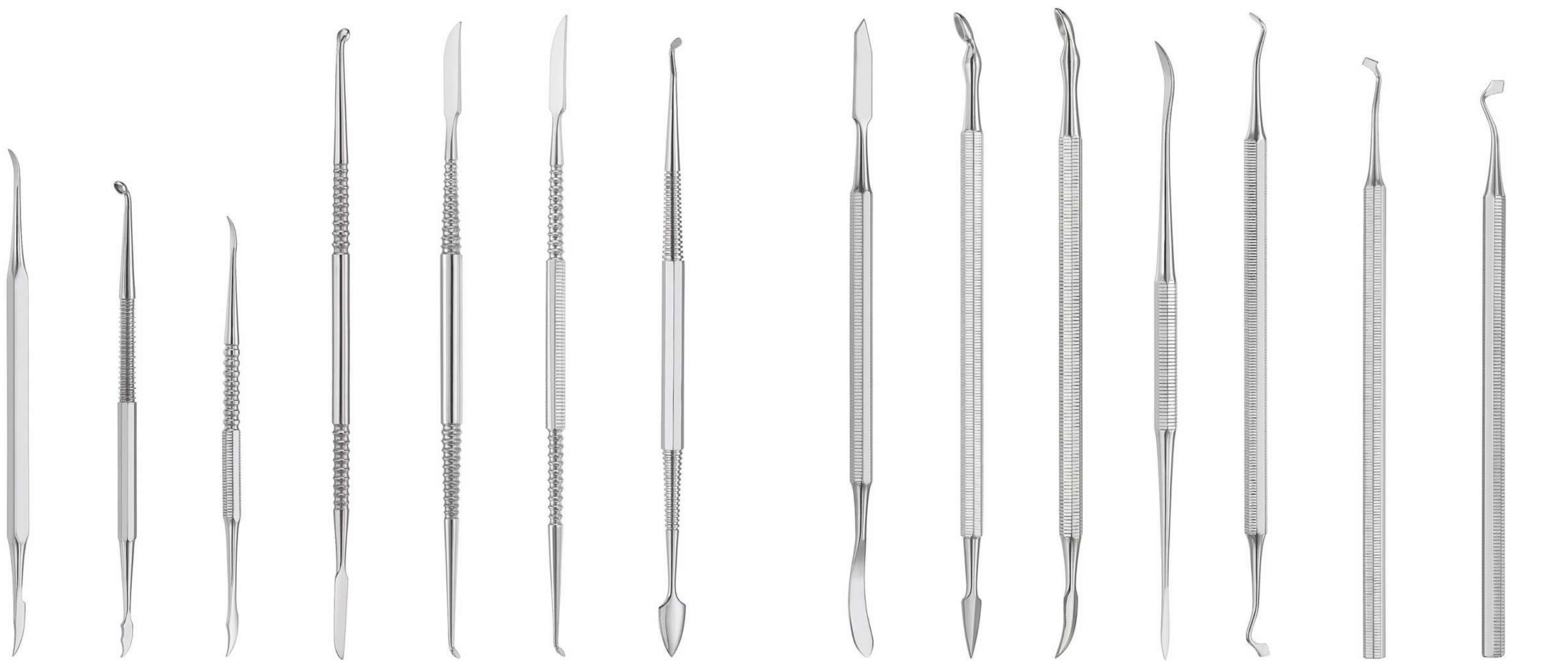

$\frac{1}{2}$	$\frac{1}{2}$	$\frac{1}{2}$	$\frac{1}{2}$	$\frac{1}{2}$	$\frac{1}{2}$	$\frac{1}{2}$	$\frac{1}{2}$	$\frac{1}{2}$	$\frac{1}{2}$	$\frac{1}{2}$	$\frac{1}{2}$	$\frac{1}{2}$	$\frac{1}{2}$	$\frac{1}{2}$	$\frac{1}{2}$
HYLIN	ZAHLE	ZAHLE	LE CRON	LE CRON	LE CRON	VEHE	FJELDSTAD	ROACH	ROACH	RIEGNER	FRAHM	FRAHM	FRAHM		
86.392.01	86.394.01	86.395.01	86.401.01	86.402.01	86.403.01	86.410.01	86.416.01	86.424.01	86.425.01	86.428.01	86.435.01	86.435.02	86.435.06	N° 1	N° 2
															N° 6



1/4	1/4	1/4	1/4	1/4	1/4
FRAHM	FRAHM	BEALE	BEALE	GRITMAN	WESTON
86.435.10 N° 10	86.436.00 N° 6110	86.462.01 N° 7A	86.462.02	86.465.01	86.472.00

19

- TECHNIKZANGEN
- MEDICAL PLIERS
- PINCES PROTHÉTIQUES
- PINZA PARA TÉCNICA
- TENAGLIE PER TECNICA

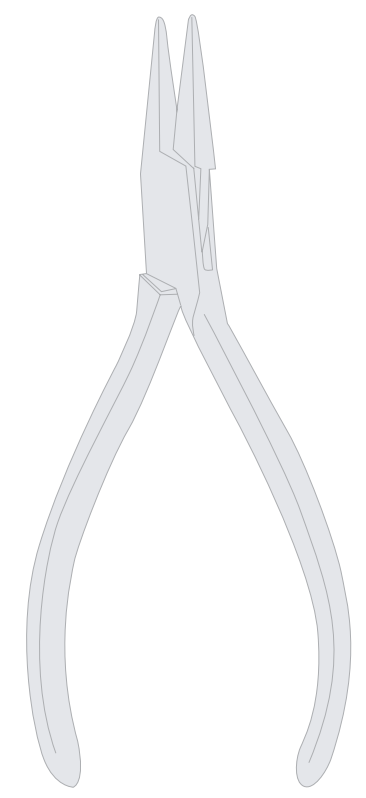



FLACHZANGEN
 FLAT NOSE PLIERS
 PINCES PLATES
 ALICATES DE PICO PLANO
 PINZE PIATTE

FLACHZANGEN
 FLAT NOSE PLIERS
 PINCES PLATES
 ALICATES DE PICO PLANO
 PINZE PIATTE



1/2
 87.505.14 14 cm 5 1/2"



1/2
LANGBECK
 87.517.14 15 cm 6"



1/2
 87.518.14 14 cm 5 1/2"



1/2
GOSLEE
 87.523.14 14 cm 5 1/2"



1/2
GOSLEE
 87.524.14 14 cm 5 1/2"



1/2
GOSLEE
 87.525.14 14 cm 5 1/2"



1/2
 87.521.13 12,5 cm 5"



1/2
 87.522.13 13 cm 5"

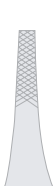

1/2
 87.522.14 14 cm 5 1/2"



1/2
 87.538.15 15 cm 6"



1/2
DUMONT
 87.554.11 11,5 cm 4 1/2"



1/2
DUMONT
 87.555.11 11,5 cm 4 1/2"



RUND- UND FLACHZANGEN
 FLAT AND ROUND NOSE PLIERS
 PINCES PLATES ET RONDES
 ALICATES DE PICO PLANO Y REDONDOS
 PINZE A PUNTE PIATTE E ROTONDE

DRAHTSCHNEIDEZANGEN
 WIRE CUTTERS
 PINCES COUPE-FILS
 ALICATES PARA DOBLAR ALAMBRE
 PINZE PIEGA FILO



1/2
 87.542.13 13 cm 5"



1/2
 87.543.13 13 cm 5"



1/2
LANGBECK
 87.544.14 14 cm 5 1/2"



1/2
 87.563.11 11 cm 4 1/4"



1/2
 87.563.12 11,5 cm 4 1/2" ■



1/2
 87.564.12 12,5 cm 5"



1/2
 87.526.12 12,5 cm 5"



1/2
 87.540.13 12,5 cm 5"



1/2
DUMONT
 87.556.11 11,5 cm 4 1/2"



1/2
 87.572.11 11,5 cm 4 1/2" ■



1/2
 87.572.12 11,5 cm 4 1/2" ■



1/2
 87.574.15 15 cm 6" ■



DRAHTBIEGEZANGEN
WIRE BENDING PLIERS
PINCES À PLIER
ALICATES PARA DOBLAR ALAMBRE
PINZE PIEGA FILO

DRAHTBIEGEZANGEN, SCHLAUFENBIEGEZANGEN
WIRE BENDING PLIERS, LOOP FORMING PLIERS
PINCES À PLIER, PINCES À FACONNER
ALICATES PARA DOBLAR ALAMBRE, ALICATES PARA PLIEGUES
PINZE PIEGA FILO, PINZE PER GRAFFE



1/2
SCHWARZ I
87.604.13 13 cm5"



1/2
SCHWARZ II
87.606.13 13 cm5"



1/2
SCHWARZ III
87.608.13 13 cm5"



1/2
MCKELLOPS-STADLER
87.626.16 16 cm6 1/4"



1/2
STADLER
87.632.15 15 cm6"



1/2
ANGLE
87.650.12 12,5 cm5"



1/2
SCHWARZ
87.612.14 14,5 cm5 3/4"



1/2
FISCHER
87.616.14 14 cm5 1/2"



1/2
MCKELLOPS
87.624.17 17 cm6 3/4"



1/2
ANGLE
87.651.12 12,5 cm5"



1/2
ANDRESEN
87.620.12 13,5 cm5 1/2"



1/2
ADAMS
87.654.13 13 cm5"



DRAHTBIEGEZANGEN, SCHLAUFENBIEGEZANGEN
 WIRE BENDING PLIERS, LOOP FORMING PLIERS
 PINCES À PLIER, PINCES À FACONNER
 ALICATES PARA DOBLAR ALAMBRE, ALICATES PARA PLIEGUES
 PINZE PIEGA FILO, PINZE PER GRAFFE

DRAHTBIEGEZANGEN, KLAMMERBIEGEZANGEN
 WIRE BENDING PLIERS, LOOP FORMING PLIERS
 PINCES À PLIER, PINCES À FACONNER
 ALICATES PARA DOBLAR ALAMBRE, ALICATES PARA PLIEGUES
 PINZE PIEGA FILO, PINZE PER GRAFFE

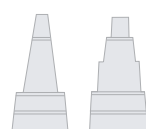

1/2
YOUNG
 87.660.13 13 cm 5"

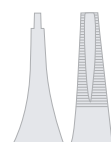

1/2
TWEED
 87.661.14 13,5 cm 5 1/2"



1/2
TWEED
 87.662.14 13,5 cm 5 1/2"



1/2
ADERER
 87.666.14 14 cm 5 1/2"



1/2
KOEHLER
 87.667.12 12 cm 4 3/4"



1/2
 87.668.14 14 cm 5 1/2"



1/2
DE LA ROSA
 87.663.00 12,5 cm 5"



1/2
DE LA ROSA
 87.663.02 12,5 cm 5"

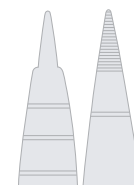

1/2
JARABAK
 87.664.14 14 cm 5 1/2"



1/2
ADERER
 87.672.12 11,5 cm 4 1/2"



1/2
ADERER
 87.674.13 12,5 cm 5"



KRAMPONZANGEN
 UNIVERSAL BENDING PLIERS
 PINCES UNIVERSELLES À CRAMPON
 ALICATES UNIVERSALES
 PINZE PIEGHE UNIVERSALE

BANDABNEHMEZANGEN
 BAND REMOVING PLIERS
 PINCES ENLÈVE BAGUES
 ALICATES PARA QUITAR BANDAS
 PINZE ASPORTABANDE



1/2
ANGLE
 87.678.13 13 cm5"



1/2
ANGLE
 87.679.13 13 cm5"



1/2
WALDSACHS-UNIVERSAL
 87.690.15 15,5 cm6"



1/2
OLIVER-JONES
 87.705.15 15 cm6"



1/2
OLIVER
 87.707.15 15 cm6"

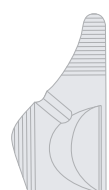

1/2
UNIVERSAL
 87.694.15 15,5 cm6"



1/2
UNIVERSAL
 87.697.15 15,5 cm6"



1/2
OLIVER
 87.709.15 15 cm6"



1/2
ADERER
 87.710.13 13,5 cm5 1/4"

Polster aus Teflon
 teflon inserts
 rembourrage en téflon
 bocas de teflón
 cuscino di teflon



LIGATURZANGEN
LIGATURE PLIERS
PINCES À LIGATURE
ALICATES PARA LIGADURAS
TENAGLIE PER LEGATURE

KONTURZANGEN
CONTOURING PLIERS
PINCES À CONTOURER
ALICATES PARA CONTOURNEAR
TENAGLIE PER PROFILI



1/2

WEINGART

87.711.14 14 cm 5 1/2"



1/2

WEINGART

87.713.14 14 cm 5 1/2"

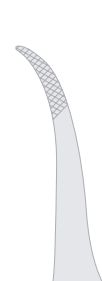

1/2

KORKHAUS

87.714.05 16,5 cm 6 1/2"



1/2

PEESO

87.742.12 12 cm 4 3/4"



1/2

PEESO

87.744.14 13,5 cm 5 1/4"



1/2

PEESO

87.770.14 14 cm 5 1/2"



1/2

ANGLE

87.796.13 13 cm 5"



1/2

ANGLE

87.797.13 13 cm 5"



1/2

FREVERT

87.776.12 12 cm 4 3/4"

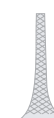

1/2

TRIPLEX

87.780.14 14 cm 5 1/2"



1/2

REYNOLD

87.783.12 13 cm 5"





KONTURZANGEN
 CONTOURING PLIERS
 PINCES À CONTOURE
 ALICATES PARA CONTORNEAR
 TENAGLIE PER PROFILI



½
GORDON
 87.785.14 14 cm 5½"

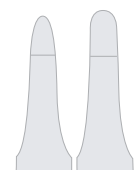

½
JOHNSON
 87.788.13 13,5 cm 5¼"

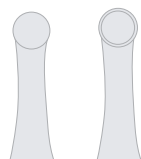

½
ABELL
 87.794.13 13 cm 5"

20

- HYGIENE
- HYGIENE
- HYGIÈNE
- HIGIENE
- IGIENE



Beispiel
 example
 exemple
 ejemplo
 esempio



½
ABELL
 87.798.00 22 cm 8¾"
 Ständer
 support
 support
 soporte
 supporto



NANCE
 87.771.13 12,5 cm 5"
 Stufenbiegezange
 step loop bending plier
 pince à courber à gradins
 alicate para doblar escalonada
 pinza piegata a gradini



FURRER
 87.702.15 15 cm 6"
 Kupferring Abnehmzange
 copper ring removing pliers
 pince enlève bagues en cuivres
 alicate para quitar anillos en cobre
 pinza aspartabande di rame

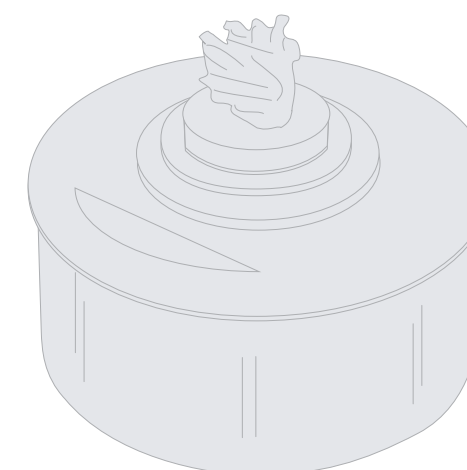



½

DAVIS

28.102.16	16 cm 6¼"
28.102.20	20 cm 8"
28.102.24	24 cm 9½"



½

UNIVERSAL

28.121.20	20 cm 8"
28.121.28	28 cm 11"



½

UNIVERSAL

28.120.20	20 cm 8"
28.120.28	28 cm 11"



CHEATTLE

28.110.27	27 cm 10¾"
-----------	------------



ROGGE

28.130.23	23 cm 9"
-----------	----------



28.140.20	20 cm 8"
28.140.30	30 cm 12"



87.912.12 120 ml



87.904.07 75 ml



87.901.12 100 ml



87.920.12 120 ml



87.924.05 50 ml



87.947.04 12 cm 4¾"



CONTAINER
CONTAINERS
CONTENEURS
CONTENEDORES
CONTAINER

Mikrocontainer aus Edelstahl
micro containers made of stainless steel
micro conteneurs en acier inoxydable
micro contenedores de acero inoxidable
micro container de acciaio inossidabile



	L x B x H	L x B x H
88.290.01	200 x 140 x 45 mm	220 x 165 x 55 mm
88.290.04	280 x 195 x 45 mm	300 x 220 x 55 mm
88.290.05	265 x 255 x 45 mm	285 x 280 x 55 mm

Sterilisierkassetten mit Silikon-Noppenstreifen
sterilization cases with silicone cushioning stripes
cassettes de stérilisation avec picots en silicone
casetes de esterilización con bandas de silicona acolchada
sterilizzazione dei cassette con imbottitura strisce di silicone



Dentalcontainer aus Aluminium
dental containers made of aluminium
conteneurs dentaires en aluminium
contenedores dentales de aluminio
container dentali de alluminio



	L x B x H
88.650.01	310 x 190 x 40 mm
88.650.02	310 x 190 x 65 mm
88.650.03	310 x 190 x 130 mm



LAGERUNGSTRAY
STORAGE TRAY
BACINELLE À STOCKAGE
TRAY PARA DEPOSITAR
BACINELLE PER IL DEPOSITO



	L x B x H	
88.698.39	265 x 175 x 43 mm	Siebkorb aus Edelstahl
88.698.00		1 stainless steel basket
88.698.38		2 paniers grillagés d'acier inoxydable
		cesta perforada de acero inoxidable
		cestino perforato di acciaio inossidabile



88.695.01	60 x 40 mm	Einschlagtuch aus Baumwolle
88.695.02	65 x 65 mm	cotton wrapping cloth
88.695.03	85 x 85 mm	tissu en coton
		pañños de algodón
		telo de cotone



	L x B x H	
88.118.50	50 x 25 x 4,5 mm	Nadeldose
88.118.65	65 x 42 x 8 mm	needle case
88.118.75	75 x 25 x 4,5 mm	boîte à aiguille
		estuche para agujas
		scatola per aghi



LAGERUNGSTRAY
 STORAGE TRAY
 BACINELLE (ODER PLATEAUX) À STOCKAGE
 TRAY PARA DEPOSITAR
 BACINELLE PER IL DEPOSITO



88.121.65B für 5 Instrumente
 for 5 instruments
 pour 5 instruments
 para 5 instrumentos
 per 5 strumenti



88.121.70B für 10 Instrumente
 for 10 instruments
 pour 10 instruments
 para 10 instrumentos
 per 10 strumenti



88.121.69B für 20 Instrumente
 for 20 instruments
 pour 20 instruments
 para 20 instrumentos
 per 20 strumenti

aus Edelstahl
 made of stainless steel
 en acier inoxydable
 de acero inoxidable
 de acciaio inossidabile

21

- VERSCHIEDENES
 MISCELLANEOUS
 DIVERS
 DIVERSOS
 DIVERSI

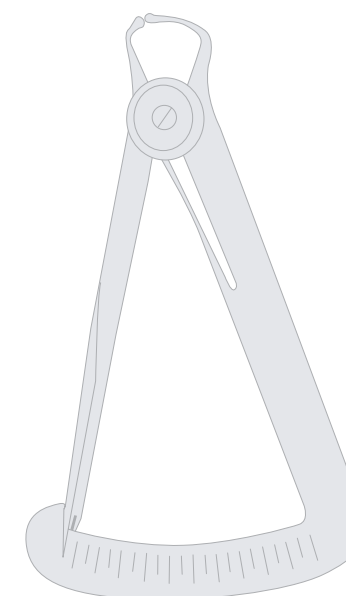



VERSCHIEDENES
MISCELLANEOUS
DIVERS
DIVERSOS
DIVERSI

VERSCHIEDENES
MISCELLANEOUS
DIVERS
DIVERSOS
DIVERSI



87.220.05 Klammer für Röntgenbild
clip for x-ray
clip pour radiographie
pinza para radiografía
pinza per radiografia



74.398.00 Handwaschbürste
hand brush
brosse à mains
cepillo para uñas
spazzola per unghie



87.853.00 Messinstrument für Bracketpositionierung
bracket positioning gauge
instrument de mesure pour le positionnement des brackets
instrumento para medir la posición de los braquets
strumento di isura per el posizionamento del bracket

für Metall
for metal
pour métal
para metal
per metallo



IWANSON
87.834.15 12 cm|4¾"
0-10 mm

für Wachs
for wax
pour cire
para cera
per cera



IWANSON
87.836.15 12 cm|4¾"
0-10 mm



BOLEY
87.816.10 16 cm|6¼"
0-100 mm



87.852.00 14 cm|5½"



87.852.01 14 cm|5½"



87.852.02 12 cm|4¾"

Brackethalter
bracket holder
porte-bracket
porta bracket
porta bracket



½
CASTROVIEJO-EPKER
48.992.09 9 cm|3½" 40 mm



½
CASTROVIEJO-EPKER
48.992.18 18 cm|7" 40 mm



22

- HOCHFREQUENZ-CHIRURGIE
 HIGH FREQUENCY SURGERY
 CHIRURGIE HAUTE FRÉQUENCE
 ELECTROCIRUGÍA
 ELETTROCHIRURGIA



½

02.340.10	10 cm 4"
02.340.20	20 cm 8"
02.340.30	30 cm 12"
02.340.40	40 cm 16"



½

02.344.15	15 cm 6"
-----------	----------



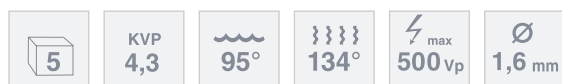

90.010.01 ø 0,2 mm N° 1 Nadelelektrode
 needle electrode
 électrode à aiguille
 electrodo de aguja
 elettrodo di ago



90.010.02 ø 0,2 mm|45° N° 2 Nadelelektrode
 needle electrode
 électrode à aiguille
 electrodo de aguja
 elettrodo di ago



90.010.11 ø 3 mm N° 11 Drahtschlingenelektrode
 wire loop electrode
 électrode anse à fil
 electrodo de asa de alambre
 elettrodo di ansa di filo



90.010.12 ø 5 mm N° 12 Drahtschlingenelektrode
 wire loop electrode
 électrode anse à fil
 electrodo de asa de alambre
 elettrodo di ansa di filo



90.010.13 ø 8 mm N° 13 Drahtschlingenelektrode
 wire loop electrode
 électrode anse à fil
 electrodo de asa de alambre
 elettrodo di ansa di filo



90.010.33 ø 1,7 mm|45° N° 33 Kugelelektrode
 ball electrode
 électrode à boule
 electrodo de bola
 elettrodo di sfera



90.010.34 ø 3 mm|45° N° 34 Kugelelektrode
 ball electrode
 électrode à boule
 electrodo de bola
 elettrodo di sfera



90.010.35 ø 0,6 mm N° 35 Koagulations-und Fulgurationselektrode
 coagulation and fulguration electrode
 électrode de coagulation et fulguration
 electrodo para coagulación y fulguración
 elettrodo per coagulazione e folgorazione

Elektrodenanschluss
 electrode connection
 connexion d'électrode
 conexión de electrodo
 raccordo di elettrodo



90.066.02
 Erbe ICC / ACC, Storz



90.066.04



90.066.06
 Martin / Berchtold / Integra

Kabellänge 3 m
 cable length 3 m
 encablure 3 m
 longitud del cable 3 m
 lunghezza cavo 3 m

Handgriff für 1,6 mm Schaft-Elektrode
 handle for 1,6 mm shaft-electrode
 manche pour électrode avec tige de 1,6 mm
 mango para electrodos con asta de 1,6 mm
 manico per elettrodi con asta de 1,6 mm



► Wenn Sie Interesse an weiteren Elektroden haben, kontaktieren Sie uns gerne.
 In case you are interested in other electrodes, please do not hesitate to contact us.
 Si vous vous intéressez à d'autres électrodes, n'hésitez pas à nous contacter.
 En caso de que se interesen por otros electrodos, no tardarían en contactarnos.
 Se avete interesse a altri elettrodi, non esitate a contattarci.

23

- NUMMERISCHES VERZEICHNIS
NUMERICAL INDEX
INDEX NUMÉRIQUE
ÍNDICE NUMÉRICO
INDICE NUMERICO

02		06.212.00	9	08.285.11	16	08.825.12	22	10.130.14	29	14.123.11	43	24.174.15	55	32.117.15	63	40.290.21	4	48.235.19	51	80.004.00	92	80.851.09	137
		06.212.02	9	08.285.15	16	08.831.12	24	10.170.12	28	14.123.13	43	24.180.16	55	32.119.15	63	40.294.05	4	48.250.16	89	80.007.00	93		
02.340.10	246	06.215.00	9	08.285.18	16	08.835.12	24	10.173.12	28	14.123.14	43	24.180.18	55	32.131.15	63	40.295.06	3	48.250.18	89	80.013.00	93	81	
02.340.20	246	06.215.01	9	08.286.15	17	08.850.10	24	10.174.12	28			24.184.16	55	32.133.15	63	40.295.07	3	48.255.16	89	80.017.00	93		
02.340.30	246	06.218.00	9	08.287.15	17	08.851.10	24	10.176.12	28	16		24.184.18	55	32.201.18	64	40.295.08	3	48.255.99	89	80.018.00	94	81.001.00	108
02.340.40	246	06.219.00	9	08.288.14	16	08.853.10	24	10.180.12	28			24.194.18	55	32.211.15	64	40.295.09	3	48.265.12	87	80.018.01	94	81.001.01	108
02.344.15	246	06.220.00	9	08.289.14	16	08.854.12	24	10.186.12	28	16.110.20	44	24.214.18	55	32.213.15	64	40.295.10	3	48.265.14	87	80.022.00	94	81.001.02	108
		06.221.00	9	08.292.14	17	08.855.12	24	10.220.17	30	16.111.20	44	24.224.15	56	32.216.18	64	40.295.11	3	48.267.12	87	80.023.00	95	81.003.00	109
		06.222.00	9	08.293.14	17	08.901.11	26	10.224.17	30			24.224.18	56	32.217.18	64	40.295.12	3	48.270.16	87	80.024.00	95	81.003.04	109
		06.223.00	9	08.296.14	17	08.901.14	26	10.230.17	30	18		24.226.15	56	32.386.20	65	40.295.15	3	48.270.19	87	80.029.00	95	81.003.09	109
		06.224.00	9	08.297.14	17	08.901.16	26	10.260.12	30			24.280.14	56	32.407.19	65	40.297.06	3	48.272.13	87	80.033.00	96	81.005.00	110
04.165.00	2	06.302.09	10	08.302.14	15	08.901.18	26	10.260.15	30	18.102.12	46	24.280.18	56	32.409.13	65	40.297.07	3	48.274.09	87	80.033.01	96	81.006.00	110
04.165.01	2	06.302.13	10	08.303.14	15	08.901.20	26	10.270.12	30	18.120.00	46	24.360.18	56	32.470.00	68	40.297.08	3	48.274.11	87	80.033.03	96	81.010.04	110
04.165.02	2	06.304.15	10	08.304.14	15	08.950.15	26	10.270.15	30	18.120.14	46	24.364.18	56	32.470.01	68	40.297.09	3	48.274.13	87	80.033.06	97	81.010.09	111
04.165.03	2	06.408.01	10	08.305.14	15	08.950.15B	26	10.272.15	30	18.120.15	46	24.370.14	57	32.470.02	68	40.297.10	3	48.274.15	87	80.034.00	97	81.015.00	111
04.165.04	2	06.408.02	10	08.306.11	18	08.950.15G	26	10.274.17	31	18.120.17	46	24.370.17	57	32.470.03	68	40.297.11	3	48.314.00	89	80.035.00	97	81.016.00	111
04.165.11	2			08.306.11	18	08.950.15Y	26	10.276.17	31	18.120.18	46	24.374.14	57	32.470.05	68	40.297.12	3	48.330.00	88	80.036.02	98	81.016.09	112
04.165.12	2	08		08.308.14	15	08.950.15R	26	10.288.20	31	18.160.17	46	24.374.17	57	32.496.00	68	40.297.15	3	48.330.01	88	80.041.00	98	81.017.00	112
04.165.13	2			08.309.14	15	08.950.15W	26	10.290.20	31	18.161.17	46	24.386.20	56	32.496.01	68	40.313.15	4	48.330.02	88	80.045.00	98	81.018.05	112
04.165.14	2	08.102.13	12	08.310.12	19	08.950.18	26	10.302.18	31	18.220.02	46	24.390.14	57	32.496.12	68	40.313.20	4	48.330.03	88	80.046.12	99	81.018.08	113
04.170.01	2	08.102.14	12	08.310.15	19	08.950.18B	26	10.310.18	31	18.220.03	46	24.390.17	57	32.498.00	68	40.313.25	4	48.330.09	88	80.051.00	99	81.023.00	113
04.170.02	2	08.103.13	12	08.314.12	19	08.950.18G	26	10.330.12	32	18.220.04	46	24.394.14	57	32.498.01	68	40.313.30	4	48.362.50	90	80.051.01	99	81.024.00	113
04.170.03	2	08.103.14	12	08.314.15	19	08.950.18Y	26	10.346.15	32	18.226.02	47	24.394.17	57	32.498.12	68	40.859.01	10	48.362.52	90	80.051.03	100	81.032.00	114
04.171.02	3	08.104.14	12	08.315.16	21	08.950.18R	26	10.348.15	32	18.226.03	47	24.410.14	57	32.620.02	80	40.859.02	10	48.362.54	90	80.053.00	100	81.032.01	114
04.171.03	3	08.105.14	12	08.317.16	21	08.950.18W	26	10.349.15	32	18.226.04	47	24.410.18	57	32.620.03	80	40.859.04	10	48.362.56	90	80.055.00	100	81.053.05	114
04.171.04	3	08.110.13	12	08.317.17	21			10.821.11	32	18.228.08	47	24.414.14	57	32.620.04	80	40.859.05	10	48.362.58	90	80.067.00	101	81.053.08	115
04.171.05	3	08.110.14	12	08.321.15	19	09		10.822.13	32	18.228.09	47	24.414.18	57	32.620.05	80	40.859.07	10	48.367.00	90	80.073.00	101	81.062.00	115
04.171.06	3	08.111.13	12	08.321.18	19			10.823.13	32	18.250.03	48	24.420.17	58	32.622.02	80	40.859.09	10	48.371.01	90	80.074.00	101	81.065.00	115
04.171.15	3	08.111.14	12	08.340.09	20	09.710.15	25	10.823.90	32	18.252.03	48	24.424.17	58	32.622.03	80			48.590.15	51	80.075.00	102	81.069.00	116
04.171.25	3	08.114.14	12	08.340.10	20	09.710.18	25	10.828.15	32	18.252.04	48	24.434.16	58	32.622.04	80			48.590.70	51	80.076.00	102	81.085.00	116
04.172.02	3	08.115.14	12	08.340.11	20	09.710.21	25			18.254.03	48	24.434.16	58	32.622.05	80	42		48.590.73	51	80.079.00	102	81.085.01	116
04.172.03	3	08.120.13	13	08.340.12	20	09.710.23	25	11		18.254.04	48	24.612.13	58	32.623.02	80	42.614.00	82	48.593.40	50	80.086.01	103	81.088.05	117
04.172.04	3	08.120.14	13	08.341.09	20	09.711.15	25			18.281.02	47	24.612.15	58	32.623.03	80	42.614.01	82	48.593.55	50	80.087.00	103	81.088.08	117
04.172.05	3	08.121.13	13	08.341.10	20	09.711.18	25	11.304.16	33	18.310.01	48	24.620.16	58	32.623.04	80	42.614.12	82	48.593.80	50	80.089.00	103	81.099.01	117
04.172.06	3	08.121.14	13	08.341.11	20	09.711.21	25	11.304.20	33	18.310.02	48	24.624.16	58	32.623.05	80	42.614.23	82	48.599.30	50	80.090.00	104	81.101.00	118
04.172.15	3	08.121.13	13	08.341.12	20	09.711.23	25	11.306.16	33	18.310.03	48	24.670.14	59	32.625.02	80	42.614.34	82	48.599.45	50	80.099.00	104	81.110.04	118
04.172.25	3	08.122.01	13	08.341.12	20	09.712.15	25	11.306.20	33	18.310.04	48	24.677.14	59	32.625.03	80	42.614.45	82	48.599.60	50	80.198.00	105	81.110.09	119
		08.122.02	13	08.344.11	20	09.712.18	25	11.308.16	33	18.342.05	49	24.679.14	59	32.625.04	80	42.614.56	82	48.601.16	50	80.199.00	106	81.150.00	119
		08.122.03	13	08.345.11	20	09.712.21	25	11.308.20	33	18.342.06	49	24.778.14	60	32.625.05	80	42.614.67	82	48.992.09	245	80.233.00	105	81.150.01	119
		08.122.01	13	08.351.11	20	09.712.23	25	11.308.20	33	18.342.07	49	24.920.15	60	32.625.08	80	42.614.78	82			80.235.00	105	81.150.02	120
		08.123.01	13	08.351.11	20	09.712.23	25	11.309.16	33	18.344.14	49			32.664.08	80					80.235.00	105	81.150.02	120
		08.123.02	13	08.353.11	20	09.713.15	25	11.309.20	33	18.344.20	49			32.664.10	80					80.333.09	104	81.150.03	120
		08.123.03	13	08.425.17	21	09.713.18	25			18.348.22	49			32.664.10	80					80.422.05	106	81.150.08	135
		08.124.12	14	08.427.17	21	09.713.18	25			18.348.22	49			32.694.30	66					80.422.05	106	81.150.08	135
		08.124.14	13	08.540.16	14	09.713.21	25			18.354.21	49			32.694.34	66					80.422.08	106	81.150.09	136
		08.125.12	14	08.541.16	14																		

82

82.001.05	140
82.001.08	140
82.002.00	140
82.003.00	140
82.003.01	140
82.004.05	140
82.004.08	140
82.006.00	140
82.008.00	140
82.009.00	140
82.010.00	140
82.011.00	140
82.012.00	140
82.027.00	141
82.027.01	141
82.028.00	141
82.028.01	141
82.034.00	141
82.034.09	141
82.039.00	141
82.040.00	141
82.046.00	141
82.050.00	141
82.051.00	141
82.301.00	142
82.302.00	142
82.303.00	142
82.304.00	142
82.405.01	142
82.405.02	142
82.405.03	142
82.410.01	143
82.410.02	143
82.410.03	143
82.414.01	143
82.414.02	143
82.414.03	143
82.414.04	143
82.501.01	144
82.501.02	144
82.501.03	144
82.505.01	144
82.505.02	144
82.505.03	144
82.508.01	145
82.508.02	145
82.508.03	145
82.508.04	145
82.511.00	146
82.511.01	146
82.511.02	146
82.512.00	146
82.512.01	146
82.512.02	146
82.513.00	146
82.513.01	146
82.513.02	146
82.514.00	146
82.514.01	146
82.514.02	146
82.515.00	146
82.515.01	146
82.515.02	146
82.525.01	147
82.525.02	147

82.533.20	149
82.533.21	149
82.533.22	149
82.533.23	149
82.533.70	149
82.533.71	149
82.540.20	145
82.540.25	145
82.540.30	145
82.551.05	150
82.551.08	150
82.551.08	150
82.553.05	150
82.553.08	150
82.554.05	150
82.554.08	150
82.561.01	148
82.567.01	148
82.567.02	148
82.571.01	147
82.571.02	147
82.577.01	153
82.577.02	153
82.577.03	153
82.577.04	153
82.580.00	154
82.580.01	154
82.580.02	154
82.580.03	154
82.580.04	154
82.580.05	154
82.580.06	154
82.580.07	154
82.580.08	154
82.580.09	154
82.580.10	154
82.580.11	154
82.580.90	154
82.580.91	154
82.580.99	154
82.581.01	153
82.581.02	153
82.581.06	153
82.581.07	153
82.582.01	151
82.582.02	151
82.582.03	151
82.583.09	151
82.585.01	152
82.585.02	152
82.585.03	152
82.587.01	151
82.590.04	152
82.590.05	152
82.590.06	152
82.600.18	156
82.600.22	156
82.601.18	156
82.601.22	156
82.602.18	158
82.602.22	158
82.603.18	159
82.603.22	159
82.603.51	156
82.603.52	156
82.606.18	158
82.606.22	158
82.608.18	157

83

82.608.22	157
82.609.18	157
82.609.22	157
82.610.42	159
82.611.18	157
82.652.00	160
82.652.01	160
82.661.00	160
82.702.16	162
82.702.20	162
82.702.22	162
82.702.24	162
82.703.22	162
82.703.24	162
82.704.20	162
82.704.22	162
82.704.24	162
82.705.20	162
82.705.22	162
82.705.24	162
82.706.20	162
82.706.22	162
82.706.24	162
82.721.04	163
82.721.14	163
82.726.01	163
82.728.00	164
82.728.01	164
82.730.01	164
82.731.00	164
82.738.01	165
82.738.02	165
82.738.03	165
82.738.04	165
82.738.05	165
82.738.06	165
82.738.07	165
82.738.08	165
82.738.09	165
82.820.10	69
82.820.20	69
82.821.01	69
82.821.02	69
82.822.10	69
82.822.20	69
82.823.01	69
82.823.02	69
82.826.10	69
82.826.20	69
82.827.01	69
82.827.02	69
82.828.10	69
82.828.20	69
82.829.01	69
82.829.02	69
82.851.01	70
82.859.00	70
82.859.10	70
82.859.11	70
82.863.00	70
82.863.10	70
82.863.11	70
82.871.11	71
82.871.11R	71
82.871.22	71
82.871.22R	71
82.871.33	71

82.871.33R	71
82.889.11	72
82.889.22	72
82.890.05	72
82.895.01	73
82.895.02	73
82.895.03	73
82.895.04	74
82.895.05	74
82.896.01	74
82.898.17	75
82.899.16	75
82.902.18	76
82.905.22	76
82.905.23	76
82.906.12	74
82.909.01	72
82.909.24	78
82.910.09	78
82.921.14	77

83.109.01	36
83.109.02	36
83.109.03	36
83.109.04	36
83.115.03	37
83.115.04	37
83.120.12	37
83.121.12	37
83.230.01	168
83.231.01	168
83.237.00	168
83.239.01	168
83.239.02	168
83.243.01	168
83.243.02	168
83.245.01	168
83.245.02	168
83.245.03	168
83.245.33	168
83.245.38	168
83.250.00	169
83.250.01	169
83.250.02	169
83.250.03	169
83.250.04	169
83.250.05	169
83.250.06	169
83.250.07	169
83.250.08	169
83.251.11	170
83.271.02	170
83.277.01	170
83.277.03	170
83.277.10	170
83.282.02	171
83.283.02	171
83.290.02	174
83.290.04	174
83.290.14	174
83.291.08	174
83.292.29	171
83.293.01	171
83.293.02	171
83.293.06	174
83.295.02	174
83.295.04	174
83.296.04	171
83.308.30	172
83.308.33	172
83.312.02	171
83.312.03	171
83.312.07	171
83.312.13	171
83.312.14	171
83.315.07	173
83.315.10	173
83.315.11	173
83.316.02	173
83.316.03	173
83.316.19	173
83.317.10	173
83.326.01	175
83.326.02	175
83.326.03	175
83.326.04	175
83.326.05	175
83.326.06	175

84

83.326.07	175
83.326.08	175
83.326.09	175
83.326.10	175
83.326.11	175
83.326.21	175
83.327.02	176
83.327.02H1	177
83.327.04	176
83.327.04H1	177
83.327.06	176
83.327.06H1	177
83.327.08	176
83.327.08H1	177
83.327.10	176
83.327.10H1	177
83.327.12	176
83.327.12H1	177
83.327.13	176
83.327.13H1	177
83.327.14	176
83.327.14H1	177
83.327.16	176
83.327.16H1	177
83.328.06	172
83.328.61	172
83.329.24	172
83.330.00	172
83.331.15	178
83.331.16	178
83.332.16	178
83.339.02	178
83.340.22	178
83.344.01	179
83.345.01	179
83.346.01	179
83.346.02	180
83.346.10	180
83.352.02	179
83.352.08	179
83.352.10	179
83.352.11	179
83.352.12	179
83.354.00	179
83.355.00	179
83.357.02	180
83.358.02	180
83.362.01	181
83.362.11	181
83.363.03	181
83.363.04	181
83.363.05	181
83.363.06	181
83.391.02	182
83.391.06	182
83.391.08	182
83.391.09	182
83.391.10	182
83.391.66	182
83.392.05	184
83.394.01	182
83.394.06	182
83.394.08	182
83.397.14	182
83.397.54	182
83.397.55	182
83.397.65	182

83.399.01	185
83.401.01	183
83.401.02	183
83.401.03	183
83.401.05	183
83.401.06	183
83.401.07	183
83.401.08	183
83.401.23	183
83.401.42	183
83.405.03	183
83.405.06	183
83.405.23	183
83.405.54	183
83.421.02	184
83.421.05	184
83.421.09	184
83.439.16	185
83.441.17	185
83.442.03	185
83.443.03	185
83.444.02	185
83.446.17	186
83.446.19	186
83.446.21	186
83.452.05	186
83.452.06	186
83.452.07	186
83.452.08	186
83.452.09	186
83.452.10	186
83.452.11	186
83.452.12	186
83.452.13	186
83.452.14	186
83.452.15	186
83.462.41	187
83.462.59	187
83.462.61	187
83.462.65	187
83.462.71	187
83.462.73	187
83.462.75	187
83.481.05	187
83.481.13	187
83.481.14	187
83.481.15	187
83.481.17	187
83.481.18	187
83.481.19	187
83.485.05	188
83.485.13	188
83.485.14	188
83.485.17	188
83.485.35	188
83.494.26	188
83.494.27	188
83.494.28	188
83.494.29	188
83.500.08	189
83.500.09	189
83.500.10	189
83.500.11	189
83.500.12	189
83.501.01	189
83.502.25	190
83.502.60	190

83.504.13	190
83.511.08	189
83.524.13	190
83.525.13	190

84.251.06	197
84.251.07	197
84.251.08	197
84.251.09	197
84.261.01	197
84.261.02	197
84.261.03	197
84.261.04	197
84.261	

87.556.11	226	87.836.15	245
87.563.11	227	87.852.00	244
87.563.12	227	87.852.01	244
87.564.12	227	87.852.02	244
87.572.11	227	87.853.00	244
87.572.12	227	87.901.12	239
87.574.15	227	87.904.07	239
87.604.13	228	87.912.12	239
87.606.13	228	87.920.12	239
87.608.13	228	87.924.05	239
87.612.14	228	87.947.04	239
87.616.14	228		
87.620.12	229	88	
87.624.17	228		
87.626.16	229	88.118.50	241
87.632.15	229	88.118.65	241
87.650.12	229	88.118.75	241
87.651.12	229	88.121.65	242
87.654.13	229	88.121.69	242
87.660.13	230	88.121.70	242
87.661.14	230	88.290.01	240
87.662.14	230	88.290.04	240
87.663.00	230	88.290.05	240
87.663.02	230	88.650.01	240
87.664.14	230	88.650.02	240
87.666.14	231	88.650.03	240
87.667.12	231	88.695.01	241
87.668.14	231	88.695.02	241
87.672.12	231	88.695.03	241
87.674.13	231	88.698.00	241
87.678.13	232	88.698.38	241
87.679.13	232	88.698.39	241
87.690.15	232		
87.694.15	232	90	
87.697.15	232		
87.702.15	236	90.010.01	248
87.703.12	215	90.010.02	248
87.703.15	215	90.010.11	248
87.705.15	233	90.010.12	248
87.707.15	233	90.010.13	248
87.709.15	233	90.010.33	248
87.710.13	233	90.066.02	249
87.711.14	234	90.066.04	249
87.713.14	234	90.066.06	249
87.714.05	234		
87.740.16	216		
87.742.12	235		
87.744.14	235		
87.750.14	216		
87.751.14	216		
87.754.00	216		
87.754.12	216		
87.757.18	214		
87.760.14	215		
87.770.14	235		
87.771.13	236		
87.776.12	235		
87.780.14	235		
87.783.12	235		
87.785.14	236		
87.788.13	236		
87.794.13	236		
87.796.13	234		
87.797.13	234		
87.798.00	236		
87.816.10	245		
87.834.15	245		

24

- INHALTSVERZEICHNIS
 ALPHABETIC INDEX
 INDEX ALPHABÉTIQUE
 ÍNDICE ALFABÉTICO
 INDICE ALFABETICO

A

ABELL	236
ACORN	196
ADAMS	90,229
ADERER	231,233
ADSON	4,28,65
ADSON MICRO	28
AINSWORTH	207
ALAR HOOKLET	47
ALBRECHT	138
ALLIS	44
ALLIS-BABY	44
ALM	52
AMALGAM INSTRUMENTS	195
AMALGAM PLUGGER	192
ANDRESEN	229
ANGLE	229,232,234
ANTKOVIK	213
APICAL	142,144
APICAL-FLOHR	142
ARRUGA	58
ARTICULATING PAPER FORCEPS	214
ASH	200
ATRAUMATIC TISSUE FORCEPS	33

B

BABCOCK	44
BACKHAUS	43
BALDWIN	199
BALL	196
BANDAGE SCISSORS	26
BAND REMOVING PLIERS	233
BARRY	152
BAUMGARTNER	54
BAUSCH	214
BEALE	222
BEEBEE	24
BENNET	200
BEYER	64
BERNARD	153,154
BLACK	168,192
BOEHM	215
BOLEY	245
BONE CURETTES	68
BONE FILES	73
BONE HOLDING FORCEPS	65
BONE RONGEURS	62
BRACKET HOLDER	244
BREWER	207
BUNTING	173
BURNISHERS	196
BYRD	10,2
BLUMENTHAL	63
BOEHLER	64
BOWDLER-HENRY	51
BOWMAN	82
BROPHY	31
BRUENINGS	84
BUCHWALD	84
BUCK	23

C

CASTROVIEJO-EPKER	245
CASTROVIEJO	59
CAWOOD-MINNESOTA	86
CEMENT SPATULAS	203
CHEATLE	238
CHEEK RETRACTORS	51,86
CHIN RETRACTOR	50
CHISELS	79
CHISELS AND GOUGES	80
CHOMPRET	70,153
CLEOIDS-DISCOIDS	181
CLEVELAND	62
COLEMANN	142,144,145,147
COLUMBIA	174
CONTAINERS	240
CONTOURING PLIERS	235
COUPLAND	2
CRANE-COGSWELL	140
CRANE-KAPLAN	172,174
CRILE	41
CRILE-MURRAY	55
CRILE-WOOD	54
CROWN REMOVER	215
CROWN SETTER	214
CROWN SPLITTER	216
CRYER	119,120,136,140
CUMINE	171
CURETTES	174
CUSHING	30

D

DARBY-PERRY	170,186
DAVIS	238
DEAN	21
DEAVER	14
DE BAKEY	16,33,55
DE LA ROSA	230
DENHARDT	87
DENTAL EXPLORERS	182
DENTAL TWEEZERS	34
DENTIMETER	216
DIDNER	205
DINGMANN	65,88
DISPOSABLE SCALPELS	9
DISSECTING FORCEPS	28
DISSECTING SCISSORS	16
DOYEN	85
DOYEN-JANSEN (MOLT)	87
DUMONT	225,226
DYCAL	198

E

EAMES	193
EISELSBERG	23
ELECTRODES	248
ELEVATORS	75
ELLIOT	193
ENAMEL CHISELS	188
EXCAVATORS	186

EXTRA. FORCEPS, AME. PATTERN	108
EXTRA. FORCEPS, ENG. PATTERN	92
EXTRACTING FORCEPS FOR CHILDREN	
ENGLISH PATTERN	128
EXTRACTING FORCEPS FOR CHILDREN	
AMERICAN PATTERN	135

F

FAHNENSTOCK	213
FARABEUF	46
FERGUSSON	3
FINGER PROTECTOR	90
FISCHER	228
FJELDSTAD	221
FLAGG	36
FLAT NOSE PLIERS	224
FORCEPS FOR DECIDUOUS TEETH	138
FRAHM	219,221,222
FRAZIER	3
FREER	75,79
FRENZEL	84
FREVERT	235
FRIEDMAN	62
FRIEDMAN-MINI	62
FURRER	236

G

GAUZE PACKER	90
GERALD	31
GILLES	58
GILLIES	30,47
GISY-WILD	213
GOLDMAN-FOX	22,77,175,180
GORDON	236
GOSLEE	225
GRACEY	176,177
GREEN	49
GRITMAN	213,219,222
GROSS-MAIER	44
GUM SCISSORS	21

H

HALSEY	54
HALSTED-MOSQUITO	40
HAND BRUSH	244
HARRIS	111,112
HARTMANN	84
HAUBEIL	193
HEIDBRINK	151
HEIDEMANN	199
HEISTER	87
HEMINGWAY	71
HEMOSTATIC FORCEPS	40
HENAHAN	108
HIRSCHFELD	173
HOLLENBACK	193,194,219
HOW	216
HULL	118
HYGIENIST	171
HYLIN	220

I

IMPRESSION TRAYS	210
IRIS	20
IRIS SCISSORS	20
IVORY	195,205,207,208
IWANSON	245

J

JACQUETTE	171
JAMESON	18
JAMESON-WERBER	18
JACQUETTE	170
JARABAK	230
JENNINGS	87
JOHNSON	236
JOSEPH	15

K

KAY (AUSTIN)	51
KELLY	14,40
KELLY-RANKIN	41
KELLS	117
KILNER	19
KILNER-DOUGHTY	89
KIRKLAND	178
KLEIN	128,134
KNIVES	5
KOCHER-LANGENBECK	49
KOEHLE	231
KÖHLERT-WHITE	105
KORKHAUS	234

L

LANDGRAF	37
LANDMORE	197
LANGBECK	224,226
LANGE	185
LANGENBECK	48,90
LANGER	174
LAWRENCE-READ	134
LECLUSE	148
LE CRON	220
LESSMANN	213
LEXER-FINO	16
LEXER-MINI	80
LICHTENSTEIN	212
LIGATURE PLIERS	234
LINSEMANN	199
LISTER	26
LITTAUER	23
LOCKLIN	21
LONDON-COLLEGE	34,35
LOOP FORMING PLIERS	229
LUCAS	72
LUER	4,63
LUKS	189
LUNIATSCHEK	90

M

MALLETS	66
MATRIX BANDS	206
MATRIX RETAINERS	205
MAYO-HEGAR	55
MARTINI	68,70
MATHIEU	56,57
MCCALL	170,171
MCKELLOPS	228
MCKELLOPS-STADLER	229
MCKESSON	90,140,146
MEAD	63,66,72
MERIAM	35
MERSON	214
METZENBAUM	16
METZENBAUM-FINO	17
MICRO CONTAINERS	240
MICRO NEEDLE HOLDERS	59
MICRO SCALPEL BLADES	10
MICRO SCALPEL HANDLES	10
MICRO SCISSORS	25
MIDDELDORFF	49
MILLER	140,141,214,215
MILLER-APEXO	140,141
MILLER-COLBURN	73,74
MILWAUKEE	109
MITCHELL	171
MODELLING CARVERS	181,217
MOD.PARIS	216
MOESLE	199
MOLT	72,78
MONFORT	216
MORRISON	126
MOUTH GAGS	87
MOUTH MIRRORS	162
MUEHLEMANN	168

N

NABERS	180
NANCE	236
NAPKIN HOLDER	90
NEEDLE HOLDERS	54
NERVE DISSECTING SCISSORS	18
NEVIUS	117
NORTHBENT	23
NYSTROEM	205

O

OBWEGESER	50
OHL	76
OLIVER	233
OLIVER JONES	233
OLSEN-HEGAR	57
OPERATING SCISSORS	12
ORBAN	178

P

PALMER	207
PARKER	10
PARODONTOMETER	179

PARTSCH	80
PEAN	42
PEESO	235
PEET	32
PERIODONTAL FILE	173
PERIODONTOLOGY	178
PERIOSTEAL ELEVATORS	76
PERRY	37
PHYSICK	110
P. K. THOMAS	217
PLASTER SPATULAS	212
PLASTIC FILLING INSTRUMENTS	197
PLESTER	4
POCKET MARKERS	38
POTT	148
PRICHARD	172
PROBES	82
PROVIDENCE-HOSPITAL	42

R

RETRACTORS	46
REYNOLD	235
REYNOLDS	19
RIEGNER	221
ROACH	221
ROGGE	238
ROOT CANAL FORCEPS	190
ROOT CANAL PLUGGERS	189
ROOT CANAL SPREADERS	190
ROOT ELEVATORS	140
ROOT FRAGMENT ELEVATORS	151
ROOT SCREWS	126
ROUTURIER	106
RUBBERDAM CLAMP FORCEPS	207
RUBBERDAM INSTRUMENTS	207
RUBBERDAM PUNCH FORCEPS	207
RYDER	56
RYDER VASCULAR	56
ROCHESTER-OCHSNER	43
ROCHESTER-PEAN	42
ROSER-KOENIG	87
ROUX	46
RUSKIN	64

S

SACHS	214
SANVENERO	15
SCALERS	168
SCALPEL HANDLES	6
SCALPELS	5
SCHAEDEL	43
SCHARMANN	170
SCHLUGER	173
SCHURE	214
SCHWARZ	212,228
SCISSORS	11
SELFIN	74,76
SELF-RETAINING RETRACTORS	52
SEMKEN	30
SENN	46
SHORTBENT	23
SICHEL	170
SIMPLEX	86



SMITH	199
SPIRIT LAMPS	239
SPLINTER FORCEPS	32
STADLER	229
STERILE SCALPEL BLADES	6
STERILIZATION INSTRUMENTS	238
STORAGE TRAY	241
SUCTION CANNULA	3
SUCTION TUBES	2
SUGARMAN	173
SUTURING FORCEPS	32
SPENCER	23
STERNBERG	86
STEVENS	58
STIEGLITZ	32
STRANDELL-STILLE	47
SYNDESMOTOMES	153

T

TANNER	181,188
TAYLOR	31,171
THOMAS	116
THUERRIEGEL	189
TISSUE GRASPING FORCEPS	44
TOBOLD	85
TOENNIS	56
TOENNIS-ADSON	19
TOENNIS-ADSON FINO	19
TOFFLEMIRE	205
TONGUE DEPRESSOR	88
TONGUE DEPRESSORS	84
TONGUE HOLDING FORCEPS	89
TOWEL CLAMPS	43
TOWNER-JACQUETTE	172
TREYMAN	215
TRIPLEX	235
TRYFUS	216
TWEED	230

U

UNIVERSAL	24,26,232,238
UNIVERSAL BENDING PLIERS	232

V

VEHE	220
VIRTUS (RALK)	32
VOLKMANN	47,68

W

WAERHAUG	219
WAGNER	22
WAKEFILED	79
WALDSACHS-UNIVERSAL	232
WARD	51,219
WARWICK-JAMES	143,145,147
WATCHMAKER FORCEP	32
WAX KNIFES	213
WEINGART	234
WEITLANER	52
WEST-APIVCAL	151
WESTCOTT	194
WEST HEIDBRINK-APIVCAL	151
WESTON	222
W. F. BARRY	149
WHITE	183,187,196,200
WIEDER	84
WILLIAM-FOX	180
WILLIAMS	199
WILLIGER	48,66,68,69,75,77,168
WINTER	150,152
WIRE CUTTERS	227
WIRE CUTTING SCISSORS	24
WOOD	104
WOODSON	199,200
WOOD-WARD	109

Y

YOUNG	230
YOUNGER-GOOD	171,174

Z

ZAHLE	220
-------	-----

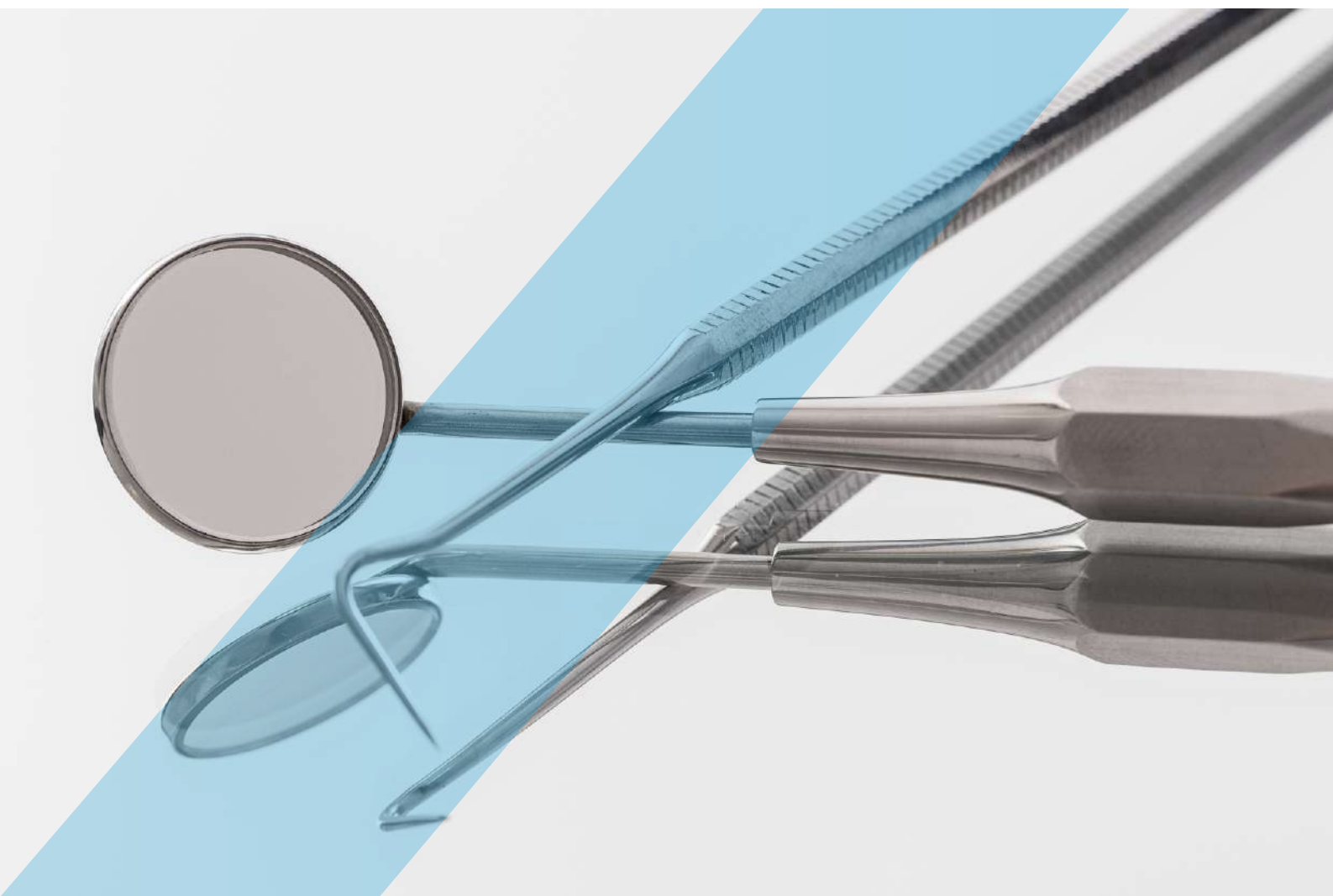

ARZTIN SURGICAL

Main Office

Szilagy Ersebet Faszor 97,
1026 Budapest, Hungary

Tel +36 20 514 7614
arztinsurgical@gmail.com

Manufacturing Unit

Defence Road P.O Small Industries Estate
51360 Sialkot, Pakistan

Tel+92 311 7900524
arztinsurgical@gmail.com



www.arztinsurgical.com